



CLINIC DESIGN

HOSPITAL BED INSTRUCTION MANUAL
IMPULSE KL-M



Dear Customers,

by purchasing a hospital bed from Malsch care & clinic design[®], you have obtained a long-lasting medical device with functions that fulfil all of the requirements of everyday hospital care while maintaining the highest safety standards.

We would like to thank you for the trust you have placed in us.

Our company guarantees carefully selected materials and continuous quality control while employing state-of-the-art production technologies.

Complying with the usage and operating instructions helps to prevent the risk of accidents and preserves the outstanding value of your hospital bed.

CONTENTS

Product range	6	Height adjustment	17
Specific function	7	Trendelenburg / Anti-Trendelenburg position	17
Environmental sustainability	7	Braking and moving	18
Notes regarding the instruction manual	8	Removable head/foot boards	19
Piktogramme / Symbolik	8	DS side rail adjustment	20
Safety instructions	9	GS side rail adjustment	22
Technical data	11	EVGS side rail adjustment	24
Rating plate	12	Function illustration	26
Rating plate with UDI	12	IMPULSE KL-M Edition 200-P (Variant for psychiatric wards)	27
Function illustration	14	IMPULSE KL-M Edition 300-P (Variant for psychiatric wards)	29
IMPULSE KL-M Edition 200-W (Version with wood surround)	15	Additional safety instructions for beds used in psychiatric wards	30
Description of function	16	DS-P side rail adjustment	31
Back rest	16	ISO standard rail with restraint grid	32
Thigh rest	16		

Delivery and assembly	33
Troubleshooting	34
Product safety	35
Cleaning and disinfection	36
Maintenance	36
Warranty and service	40
Customer service	40
Declaration of conformity	40
Certificates	41

PRODUCT RANGE



IMPULSE KL-M Edition 200-W



IMPULSE KL-M Edition 300-P



IMPULSE KL-M Edition 200-P

SPECIFIC FUNCTION

Malsch GmbH hospital beds are used in hospitals and medical environments. These beds are designed exclusively for this purpose. The comfort and functionality provided by the hospital beds make life easier for the staff in carrying out their care duties. The beds also make the positioning, compensation and relief of patients who are treated in hospitals or medical facilities easier.

If the hospital beds are to be used for other applications, prior written agreement from Malsch GmbH is required.

The product is intended for use as a care aid or health device, and is subject to the regulations of the relevant employer's liability insurance associations. The hospital bed is a medical product with regard to the applicable industry standards and regulations. This product must therefore only be used under medical supervision.

The hospital beds described in this instruction manual are approved for adult patients with a body weight of at least 40 kg and a height of at least 146 cm. In accordance with standard IEC 60601-2-52:2009/AMD1:2015, the beds must not be used by patients whose body weight and height are below these limits or with a BMI of less than 17, since the risk of injury is increased for this group.



Caution! The use of incompatible side rails and mattresses can lead to injury, since body parts may become trapped.

ENVIRONMENTAL SUSTAINABILITY

Malsch GmbH hospital beds are manufactured in accordance with the relevant regulations using state-of-the-art processing technologies, and do not contain any hazardous materials. The materials used to finish surfaces are free of CFC and solvents.

Hospital beds that are taken out of service due to their age or because of irreparable damage must be disposed of in line with the local disposal regulations.



Caution! Please observe the relevant local regulations when disposing of metal, wood and electrical waste.

NOTES REGARDING THE INSTRUCTION MANUAL

The following directions and statutory requirements in this instruction manual are intended for care staff or other persons and staff who are tasked with operating and using the hospital bed.



The instruction manual must be accessible to personnel at all times to avoid operating errors and guarantee fault-free operation. The care staff must have a good understanding of the hospital beds and be trained in their operation before using them for the first time. The instruction manual must be used for this training.

This instruction manual has been written for the IMPULSE KL-M hospital bed. The images, graphics and texts it contains may differ from the scope of delivery.



The manufacturer can provide technician training for maintenance and servicing work on their hospital beds. A certificate that is obtained as part of this training authorises the holder to carry out technical work independently on the beds.

PICTOGRAMS / SYMBOLS

For ease of reference, we sometimes use pictograms in this manual as follows:



Important!

Instructions labelled in this way must be strictly observed in order to avoid injuries or damage!



Information!

This symbol marks relevant information in its respective context.

SAFETY INSTRUCTIONS

The following safety instructions must be observed in order to prevent risks to both patients and carers, and avoid any damage to the hospital bed:

- ⚠ The instruction manual must be read and observed before using the hospital bed.
- ⚠ It is vital to observe the information given on the rating plate! The information given on the rating plate is explained in detail on [P.12](#) of this instruction manual.
- ⚠ In the event of any faults or defects that could endanger a person, the bed must not be used.
- ⚠ Mechanical hospital beds may only be operated by trained staff.
- ⚠ Before the bed is used for the first time, the operator must ensure that it is safe to use and in good condition.
- ⚠ The castors must always be placed in the braked position to ensure that the patient does not fall when getting into or out of the bed.
- ⚠ The bed can be moved into different positions. When doing so, it must be ensured that no parts of the body or other objects are located in the adjustment area.
- ⚠ Only care staff may adjust the side rails. When adjusting the sleeping surface position, it must be ensured that the patients do not come into contact with the side rails to avoid trapping any part of the body.

- ⚠ The functionality of the side rails must be checked daily. They must not bear any vertical loads exceeding 75 kg or horizontal loads exceeding 50 kg.
- ⚠ When the hospital bed is being used in a patient's room, the safety distances from walls, window ledges and other furnishings must be observed. The safety distances depend on the design and model of the hospital bed and are based on the height adjustment and the tilting motions of the bed. The minimum distance is 30 mm.
- ⚠ Improper use of the bed may result in hazards such as:
 - Use of the bed by persons with a body weight of less than 40 kg or a BMI of less than 17, or a height of less than 146 cm
[P.7 Specific function](#)
 - Moving the bed by pulling on the side rails
 - More than one person adjusting the bed at the same time
 - Activation of the functions by patients without prior instruction
 - Moving the bed on sloping or unsurfaced subsurface

- ⚠ In accordance with IEC 60601-2-52:2009/AMD1:2015, when choosing a mattress, it is important for there to be a minimum distance of 22 cm between the top of the sleeping surface and the top of the side rail in its fully extended position. The mattress that is used must fulfil the applicable safety standards.
- ⚠ For safety reasons, the grab handle on the lifting pole must be replaced completely every 5 years.
- ⚠ It is essential to avoid obstructing any part of the bed mechanism, since this can lead to damage.
- ⚠ Likewise, the safe working load must not be exceeded.
- ⚠ If an immobile patient remains in the same position for an extended period of time without the use of additional positioning aids, this can lead to pressure sores. The manufacturer of the hospital bed is not liable for this in any way.
- ⚠ Proper execution and traceable documentation of the technical checks, maintenance and servicing work prescribed by the manufacturer, as well as the technical safety checks, are required in order to maintain the purchaser's warranty rights. If the operator of a medical device does not fulfil their obligations, this could lead to the risk of damage and accidents for which the manufacturer is explicitly not liable.
- ⚠ Maintenance work must be carried out and documented by trained staff.
- ⚠ The bed should be left in the lowest position when the patient is unattended to reduce the risk of injury caused by falling out of bed.

TECHNICAL DATA

Model	Dimensions [cm]	Sleeping surface [cm]	Height adjustment [cm]	Weight	Load capacity max.	Anti- / Trendelenburg	Thigh rest adjustment	Back rest adjustment
IMPULSE KL-M Edition 200-VV Edition 200-P	100x218	90x200	40 to 80°	Approx. 120 kg	Total 250 kg 185 kg patient 20 kg mattress 45 kg accessories	–	43°	71° / 6 cm Mattress compensation
IMPULSE KL-M Edition 300 Edition 300-P	100x218	90x200	40 to 80°	Approx. 120 kg	Total 250 kg 185 kg patient 20 kg mattress 45 kg accessories	15° / 16°	43°	71° / 6 cm Mattress compensation

* measured from the sleeping surface frame

RATING PLATE



1  Malsch GmbH | Rohbergstr. 9 | D-36208 Wildeck
Tel.: +49 (0) 6626 915-100 | bettenmalsch.com







2 **REF** Hospitalbett IMPULSE KL-M

3 **SN** 0724 30000 1234567

Made in Germany

Next inspection: 08 / 2025

6  = 250 kg  = 185 kg  = 370 kg

R3.1.3 **MD**      

Example illustration of a rating plate without UDI of the IMPULSE KL-M Edition 200 hospital bed

RATING PLATE WITH UDI



1  Malsch GmbH | Rohbergstraße 9 | D-36208 Wildeck-Obersuhl
Tel.: +49 (0) 6626 915-100 | info@bettenmalsch.de | bettenmalsch.com

2 **REF** Hospitalbett IMPULSE KL-M







UDI  7

Next inspection: 08 / 2025

3 **SN** (01)4065848000168 8
(21)012104001234567
(24)0320018015121410

6  = 250 kg  = 185 kg  = 370 kg





Made in Germany R3.2.1

MD      



Example illustration of a rating plate with UDI of the IMPULSE KL-M Edition 200 hospital bed

The rating plate is located on the underside of the sleeping surface, at the head of the bed on the right. To inspect the rating plate, raise the head rest to the uppermost position.

1. Manufacturer's address
2. Model ID
3. Serial number
4. Indicates the next technical check after delivery in accordance with VDE0751-1
5. Explanation of the symbols used on the rating plate:

	Labelling as a medical device
	Conformity marking in line with the Medical Device Directive (EU) 2017/745
	"Only use in dry areas"
	"Observe the instruction manual"

6. Explanation of the symbols used on the rating plate:

	Safe working load
	Maximum permissible weight of patient
	Maximum total weight of the medical product including the patient (Weight of bed plus safe working load)

7. 2D barcode (GS1 data matrix) DI + PI = UDI
8. (DI) Device Identifier
(01) UDI-DI/GTIN

(PI) Production Identifier
(21) Serial number
(240) Additional product information

FUNCTION ILLUSTRATION

IMPULSE KL-M Edition 200-W

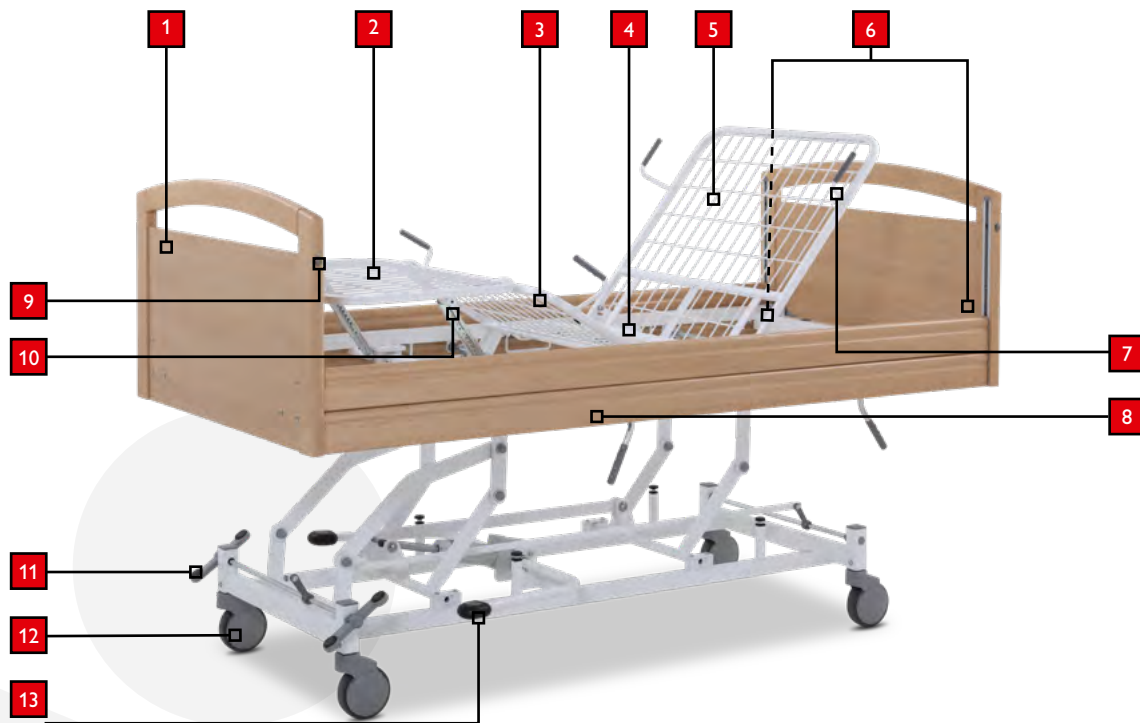

IMPULSE KL-M Edition 200-W (Version with wood surround)

1. Footboard
2. Adjustable lower leg rest
3. Adjustable thigh rest
4. Static seat section
5. Adjustable back rest
6. Receiving sleeves for IV drip holder and accessories
(4x surrounding the bed)
7. Mattress holder / handle
8. Full-length side rail
9. Release button for full-length side rail
10. Lower leg rest adjustable ratchet
11. Foot pedal with central brake (▼), fixed direction (▲)
and freewheeling (—)
12. 125 mm single castor
13. Foot pedal for hydraulic cylinder

DESCRIPTION OF FUNCTION

Back rest

The backrest is adjusted using the relevant operating levers on both sides below the sleeping surface frame.

When the operating lever is activated, the up/down movement of the back rest must be manually supported and secured by the care staff, using the handlebar on the back rest.



Caution! Before activating the lever, ensure that there are no objects or body parts in the adjustment area. Risk of crushing! When releasing the back rest, support it by making use of the handlebar on the sleeping surface frame.



Caution! The back rest is designed for the mechanical load that is applied when raising a reclining person with a maximum resident weight according to the specification on the rating plate. Sitting on the back rest is not the intended specific function, and may result in damage and injury.

Thigh rest

The thigh rest is adjusted using the relevant operating levers on both sides below the sleeping surface frame. For safety reasons, this position must only be adjusted by medical personnel.



The care staff can move the lower leg rest into a horizontal position (extended leg elevation) using the adjustable notched bracket.



Caution! Before activating the lever, ensure that there are no objects or body parts in the adjustment area. Risk of crushing! Only use the handlebar on the sleeping surface frame to apply pressure to the thigh rest.

Height adjustment

Height adjustment takes place using a hydraulic cylinder which is operated with a foot pedal.

The height of the sleeping surface can be adjusted by operating the foot pedal (Fig. A). To lower the sleeping surface, depressurise the hydraulic cylinder by slightly raising the foot pedal (Fig. B). The sleeping surface will gradually lower itself to the access height.



Fig. A



Fig. B



Caution! Please consider the safety of the patient when adjusting the height! Ensure that there are no foreign objects in the area of the lifting mechanism.

Braking and moving

The 300 and 300-P editions of the IMPULSE KL-M have a central castor brake which is operated mechanically using a central foot pedal. The foot pedals are on both sides at the foot end of the bed.



Trendelenburg / Anti-Trendelenburg position

The IMPULSE KL-M Edition 300 hospital bed is equipped with a sleeping surface swivelling mechanism as standard.

To initiate swivelling into the Trendelenburg position, the sleeping surface must be in its lowest position. Swivelling can then be initiated by operating the release pedal (in the centre at the lower foot end of the bed (Fig. C). The adjustment must be manually supported by the care staff by lifting the sleeping surface at the foot end. It is advisable to grip beneath the bed frame for lifting (Fig. D).



Fig. C



Fig. D



Caution! When the reverse Trendelenburg position is being activated in conjunction with a pulled-out bed extension, ensure that there are no objects or parts of the body below the foot end of the bed.

To initiate swivelling into the anti-Trendelenburg position, the sleeping surface must first be set to its highest position. (☞ Height adjustment - Fig. A). Swivelling can then be initiated by operating the release pedal (in the centre at the lower foot end of the bed (Fig. E)). The adjustment must be manually supported by the care staff by pressing down on the foot end of the bed. (Fig. F)



Fig. E



Fig. F



Caution! Please consider the safety of the patient when adjusting the height! Ensure that there are no foreign objects in the area of the lifting mechanism. The functions may only be activated by specialist staff. Incorrect settings may result in permanent injury to the patient.

The brake of the IMPULSE KL-M 300/300-P has 3 different settings:

1. Central braking of the castors (red foot pedal at the bottom)
2. Castors enabled for 360° movement (horizontal foot pedal)
3. 1 castor set to a fixed direction (green foot pedal at the bottom)



Caution! The sleeping surface of the IMPULSE KL-M Edition 300/300-P hospital bed can be moved to any height position. However, this should only be done in exceptional cases and under the supervision of care staff. The castor brakes should subsequently be checked in order to ensure that the bed is in a braked position after transport. Attention must be paid to the safety of the patient!

Removable head/foot boards

As standard, the Impulse KL-M hospital bed has head/foot boards that can be removed without the use of tools. These boards can be released and removed by pulling them upwards after releasing the snap lock mounted on the bed frame (green lever).

The exceptions are psychiatry versions and versions with a wood surround.

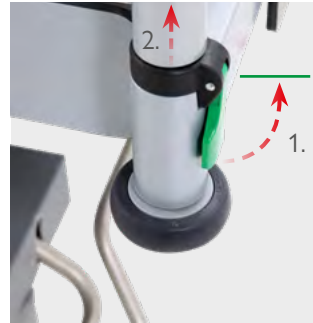

Caution! Ensure that the head/foot boards are locked before you start using the bed.



Caution! Secure the patient before removing the head/foot boards.



Caution! When inserting the head/foot boards, ensure that no objects or parts of the body are located in the hazard area.

DS side rail adjustment

Full-length side rails

In the starting position, the side rails are located on top of one another next to the sleeping surface frame.

1. Raising function:

Lift the upper side rail by the side rail groove (B) until you hear both safety buttons (A) snap into place.



Caution! Check that the side rail is locked in place by shaking it several times.

2. Lowering function:

Slightly lift the upper side rail by the side rail groove (B), while pushing in the safety button (A) at the same time. Slowly lower the side rail to the lowest position. Repeat the process at the other end of the bed.



Caution! When lowering and raising the side rails, please be extremely careful not to trap fingers, hands or any other parts of the body between the side rails and the sleeping surface frame.

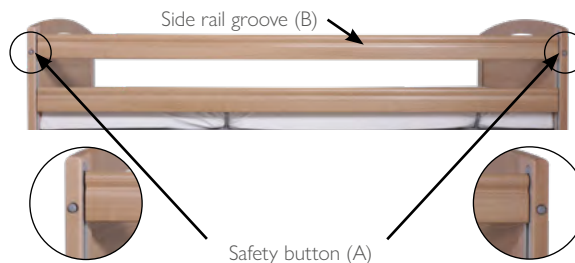

Caution! With disorientated or undernourished patients, we strongly recommend the use of side rail padding to prevent limbs from becoming trapped between the side rail gaps, which could cause injuries.

DS side rail dimensions

When using the ABS/metal lattice sleeping surface

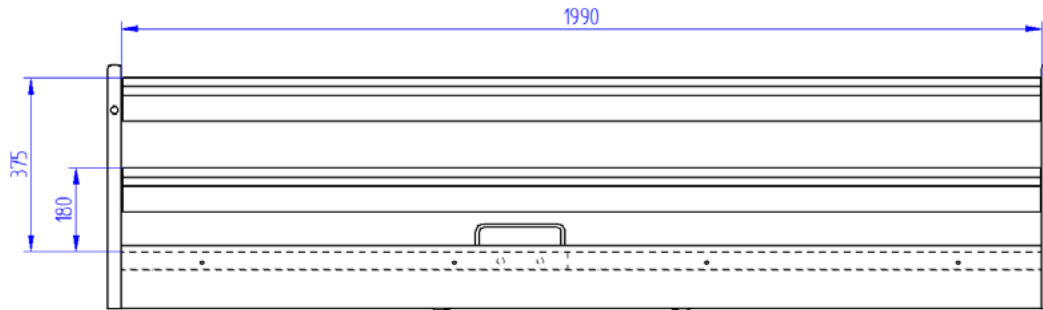

When using the comfort sleeping surface

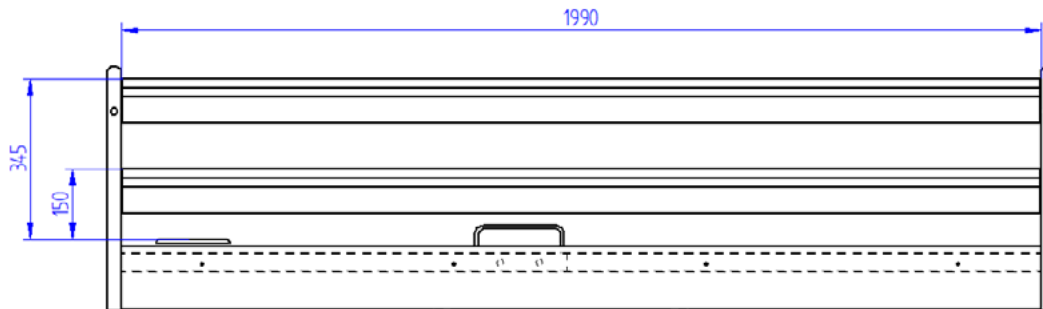

GS side rail adjustment

Split side rails

In standby position, the side rails are located next to the sleeping surface and therefore prevent the mattress from slipping. (Fig. 1)

1. The side rails are raised by tilting them upwards. In this central position, they prevent the patient from falling out of bed, and when they are raised at the head end, they also provide stable standing and mobility assistance for the patient. (Fig. 2)
2. The upright side rail is released by means of two spring catches in the side rail bars below the height adjustment handrail and positioned at its maximum height. Perform telescopic adjustments upwards and downwards using both hands simultaneously to prevent jamming (Fig. 3). **Do not use force!**
3. To lower the telescopic side rail height extension, proceed in the same way as when raising it.
4. To fold the side rails back into their standby position, press the indicated release latches on the lower side rail bar inwards simultaneously and initiate the tilting motion. (Fig. 4)



Caution! When raising the side rails and side rail height extensions, ensure and check that the latches engage securely. Always use both hands to move this element!



Fig. 1

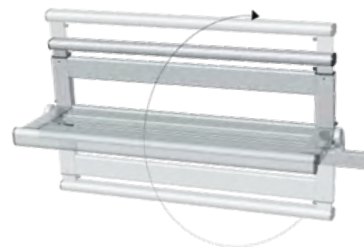

Fig. 2



Fig. 3



Fig. 4

GS side rail dimensions

When using the ABS/metal lattice sleeping surface

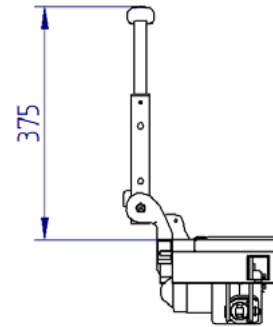
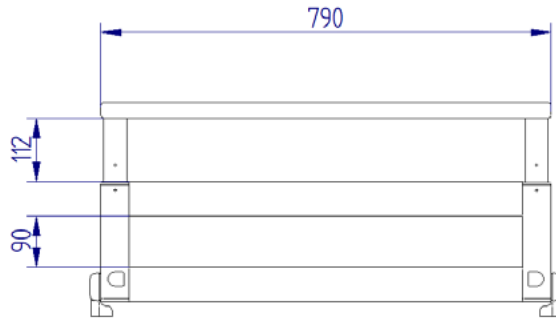

When using the comfort sleeping surface

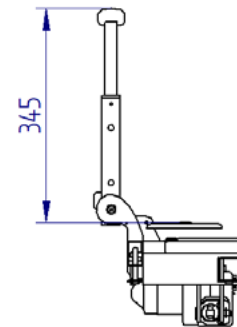
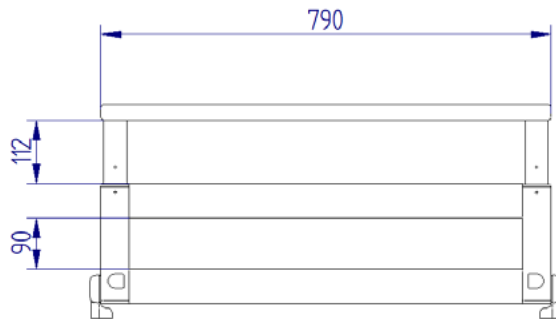

EVGS side rail adjustment

Vertically lowerable split side rails with one-handed operation

In the standby position, the side rails are located at the side of the sleeping surface and prevent the mattress from slipping.

1. To raise the side rails, pull them upwards with both hands until they engage with an audible click. In this central position, they prevent the patient from falling out of bed, and when they are raised at the head end they also provide stable standing and mobility assistance for the patient. (Fig. A, 1.)
2. The side rail extension can be released using the two spring catches below the handrail for telescopic movement and adjusted to its maximum height. Adjustment takes place by pulling the rail upwards with both hands at the same time (Fig. B, 1./2.). Take care not to jam the element. Follow these actions in the reverse order to lower the rail.
Do not use force!
3. To lower the side rails, pull the release handle forward with one hand (Fig. A, 2.) and carefully lower the side rails into the standby position.



Caution! When raising the side rails and side rail height extensions, ensure and check that the latches engage securely.



Abb. A



Abb. B

VGS side rail dimensions

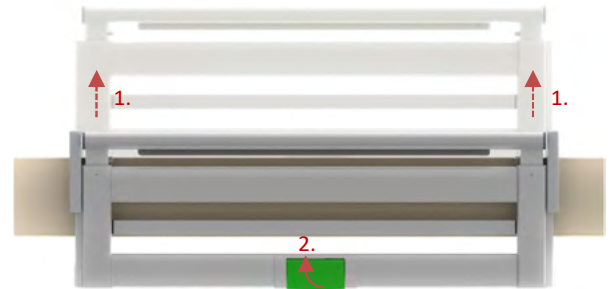
When using the ABS/metal lattice sleeping surface

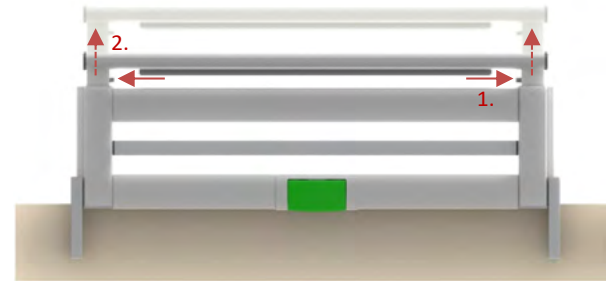
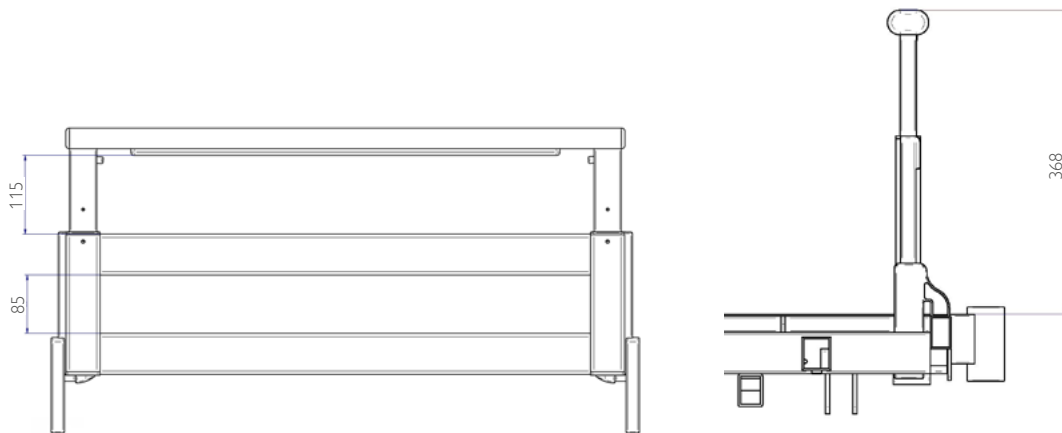

FUNCTION ILLUSTRATION

IMPULSE KL-M Edition 200-P

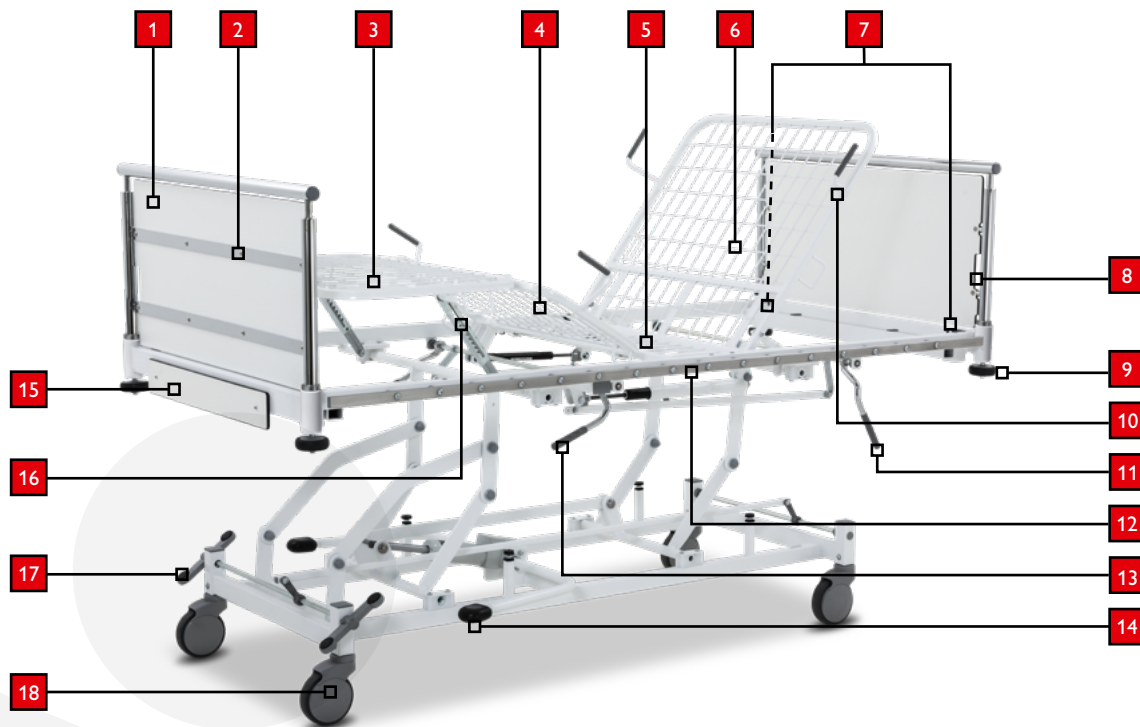

IMPULSE KL-M Edition 200-P (Variant for psychiatric wards)

1. Footboard
2. Reinforcement of the HPL panels against kicking through*
3. Adjustable lower leg rest
4. Adjustable thigh rest
5. Static seat section
6. Adjustable back rest
7. Receiving sleeves for IV drip holder and accessories (4x surrounding the bed)
8. Recess for retrofittable side rail*
9. Wall bumper (4x surrounding the bed)
10. Mattress holder / handle
11. Backrest operating lever
12. ISO standard rail with restraint grid
13. Thigh rest operating lever
14. Foot pedal for hydraulic cylinder
15. Pull-out bed linen holder*
16. Lower leg rest adjustable ratchet
17. Foot pedal with central brake (▼), fixed direction (▲) and freewheeling (—)
18. 125 mm single castor

* Optional special equipment

The following differences from the standard equipment are a result of the special adaptations of the bed to the requirements of psychiatric treatment:

- Non-removable sleeping surface elements (welded)
- Screwed-on, non-removable head/foot boards with stably attached HPL filler boards without gaps between them and the frame of the head/foot board. (To remove the head / foot boards, the wall bumpers must be loosened and removed by means of two screws M8x70. After that, the head/foot board can be pulled up and out.)
- Head/foot boards reinforced with steel rails to prevent kicking through*
- Recesses in the head/foot board for attaching the retrofittable continuous side rail
- No side rails
- Full-length side rail system with snap lock for retrofitting*
- Linen holder*
- Four firmly bolted wall bumpers
- Stainless steel DIN standard rail, full-length on both sides for holding accessories and for attaching approved restraint systems
- Two sockets for accessories at the head and foot end
- Trapeze bar mount (external) at the head end
- Powder-coated metal parts in RAL 9016

FUNCTION ILLUSTRATION

IMPULSE KL-M Edition 300-P

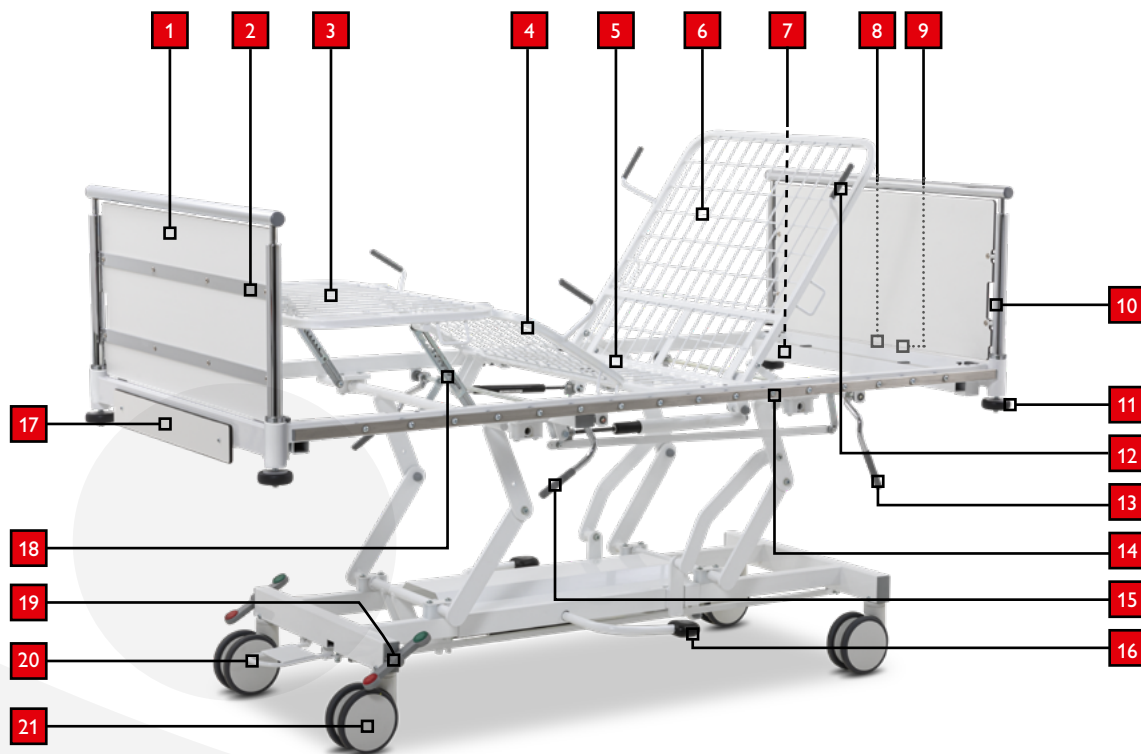

IMPULSE KL-M Edition 300-P (Variant for psychiatric wards)

1. Footboard
2. Reinforcement of the HPL panels to prevent kicking through
3. Adjustable lower leg rest
4. Adjustable thigh rest
5. Static seat section
6. Adjustable back rest
7. Receiving sleeves for IV drip holder and accessories (4x surrounding the bed)
8. Trapeze bar mount (external)
9. Potential equalisation connector (external)
10. Recess for retrofittable side rail*
11. Wall bumper (4x surrounding the bed)
12. Mattress holder / handle
13. Backrest operating lever
14. ISO standard rail with restraint grid
15. Thigh rest operating lever
16. Foot pedal for hydraulic cylinder
17. Pull-out bed linen holder*
18. Lower leg rest adjustable ratchet
19. Foot pedal with central brake (▼), fixed direction (▲) and freewheeling (—)
20. Foot lever for swivelling the sleeping surface
21. 150mm double castors

The following differences from the standard equipment are a result of the special adaptations of the bed to the requirements of psychiatric treatment:

- Non-removable sleeping surface elements (welded)
- Screwed-on, non-removable head/foot boards with stably attached HPL filler boards without gaps between them and the frame of the head/foot board. (To remove the head/foot boards, the wall bumpers must be loosened and removed by means of two screws M8 x 70. After that, the head/foot board can be pulled up and out.)
- Head/foot boards reinforced with steel rails to prevent kicking through*
- Recesses in the head/foot board for attaching the retrofittable continuous side rail
- No side rails
- Full-length side rail system with snap lock for retrofitting*
- Linen holder*
- Four firmly bolted wall bumpers
- Stainless steel DIN standard rail, full-length on both sides for holding accessories and for attaching approved restraint systems
- Two sockets for accessories at the head and foot end
- Trapeze bar mount (external) at the head end
- Powder-coated metal parts in RAL 9016

* Optional special equipment

ADDITIONAL SAFETY INSTRUCTIONS FOR BEDS USED IN PSYCHIATRIC WARDS

- ⚠ Removable accessories such as trapeze bars, IV drip stands and accessories of the DIN standard rail etc. are not recommended. The responsible staff must decide on the use of these types of accessories after assessing the health and psychological condition of the patient.
- ⚠ The use of a bed extension is not recommended for psychologically unstable patients.
- ⚠ For beds used on psychiatric wards, regular inspection for damage is urgently recommended. In case of damage, the damaged parts should be replaced immediately.
- ⚠ The bed is equipped with an electrically conductive castor. Always check the grounding of the bed by making sure that the castor marked with a yellow dot is in contact with the ground.

DS-P side rail adjustment

Full-length, removable side rail

The full-length, removable side rail is mounted at the sides into the recesses of the head/foot boards and fixed to the frame of the head/foot board with cam levers (Fig. 2).

1. Raising function:

Pull up the upper side rail bar (Fig. 3) until the safety button (A) audibly snaps into place at both sides.



Caution! Check that the side rail is locked in place by shaking it several times.

2. Lowering function:

Slightly lift (relieve) the upper side rail bar and pull out the safety button (A) at the same time (Fig. 4). Slowly lower the side rail to the lowest position.



Caution! When lowering and raising the side rails, please be extremely careful not to trap fingers, hands or any other parts of the body between the side rails and the sleeping surface frame.

Standards conformity:

- In accordance with DIN EN 60601-2-52
- Testing cone test with 250 N, safety distances < 120 mm, sleeping surface distance to top edge of side rail 340 mm, with 12 cm mattress 200–220 mm.

Fig. 1



Fig. 2



Fig. 3



Fig. 4



Safety button (A)



Caution! With disorientated or undernourished patients, we strongly recommend the use of side rail padding to prevent limbs from becoming trapped between the side rail gaps, which could cause injuries.

ISO standard rail with restraint grid

The IMPULSE Edition 300-P/400 hospital bed for psychiatric wards comes with a full length ISO standard standard rail with restraint grids at both sides of the bed. The grids are designed for straps up to 89 mm wide.



Caution! Always pay attention to the restraint regulations of your workplace, your facility's internal restraint protocol and the current legal regulations of your state! The instruction manuals from the manufacturers of the restraint systems that are used must be adhered to at all times.



Caution! Restraint systems may only be used and applied by persons who are trained or knowledgeable on the practice, and only in connection with approved restraint systems and according to the instruction manual of the system used. The legal regulations and medical instructions must be strictly observed! The attending physician must ensure that the patient's health allows for the use of a restraint system.



Caution! Erroneous use of restraint systems can lead to serious injury, or even death.



Caution! To avoid accidents while restraining a patient, the side rails must be raised (exception: 5-point restraint). With split side rails, a protector must be used to prevent the patient from slipping through.

DELIVERY AND ASSEMBLY

Malsch GmbH hospital beds are generally delivered fully assembled, or are assembled on site by company technicians or authorised staff.

Check the delivered bed against the documentation for completeness and conformity.

Any defects or damage must be pointed out to the freight company immediately and noted on the delivery document.

Signing of the delivery documents by both parties is obligatory before commissioning.

If necessary, e.g. for maintenance, simple assembly procedures can also be performed by professional authorised persons.



After service and maintenance work has been completed, the functionality of the mechanical systems must be checked.

Assembly of head/foot board/sleeping surface

- The head/foot boards can be removed without the use of tools, as they have plug connections.
- Exchange the side rails and sleeping surface cladding with the aid of suitable assembly aids and carry out a function test!



The manufacturer provides technician training for maintenance and servicing work on its hospital beds. A certificate that is obtained as part of this training authorises the holder to carry out technical work independently on the beds.

TROUBLESHOOTING

No lifting function when activating foot pedal	Pressure cylinder faulty	Replacing the pressure cylinder
Height adjustment very slow	Hydraulic cylinder faulty (oil leak)	Replacing the hydraulic cylinder
Side rails can no longer be properly adjusted	Mechanism blocked or bent	Check all moving parts and remove any obstructions, or contact our customer service team
Castors do not brake or cannot be rolled	Foreign objects have become trapped in the castors	Remove foreign objects
	The castor system is faulty	Contact customer service

PRODUCT SAFETY

This product bears the CE seal and therefore meets the requirements of the applicable German and European safety standards.

Laws and standards	Title
Regulation (EU) 2017/745	European Medical Device Regulation
MPDG	Medical devices implementation act
DIN EN ISO 13485	Quality management for medical devices – Requirements for regulatory purposes
DIN EN ISO 9001	Quality management systems
DIN EN ISO 14001	Environmental management systems
DIN EN ISO 14971	Risk management for medical devices
IEC 62366	Medical devices – Application of usability engineering to medical devices
DIN EN ISO 20417	Medical devices – Requirements for the information to be supplied by the manufacturer
DIN EN ISO 15223-1	Symbols to be used for labelling medical devices
DIN EN 12182	Technical aids for disabled persons
DIN EN 12530/DIN EN 12531	Medical castors/hospital bed castors
DIN 33402-1	Ergonomics – Body dimensions of people
DIN 68861-1	Furniture surfaces – Resistance to chemical attack

CLEANING AND DISINFECTION

Disinfection

The care bed must be disinfected regularly, at least before every change of resident. All detergents in accordance with DIN EN 12720 are suitable for wipe-down disinfection of the bed. The care bed must not be disinfected in inline washing systems or using water spray. Only those disinfectants recommended by the RKI are permitted to be used for wipe and surface disinfection at the specified concentration. Complaints resulting from improper use, e.g. using hand disinfectant for disinfecting surfaces, are ruled out.

The detergents used for disinfection must only be used in accordance with the manufacturer's instructions.



Caution! Under no circumstances must abrasives, cleaning pads or stainless steel cleaners be used for cleaning. Before using any disinfectants, please consider the dosage and any potential hazards that may be caused by combining them with other substances. Remove the plug from the mains socket when disinfecting the hospital bed and protect the drive system from moisture.

MAINTENANCE

The manufacturer is only liable for the safety and reliability of the product if it is serviced regularly and used in accordance with the safety instructions. If any significant faults are found during maintenance work which mean that the safe operation of the product cannot be guaranteed, the product must be taken out of use. Maintenance work must be carried out at least **once a year**.

The regulations of the general operator ordinance apply.



Any defects which impair the function and safety of the hospital bed must be resolved before the bed is used again and must be reported to the responsible person.

Only original replacement parts from Malsch GmbH are permitted to be used.Procedure

Procedure

1. Visual inspection

Check the welded structures for cracked weld seams and for plastic deformation and wear. The welded structures include the undercarriage and the sleeping surface with the moving interior components. Also check that all screw joints are firmly connected.

2. Level of protection and functionality check of the side rails

During the functionality check, determine whether the side rails can be easily locked in place and ensure that no impermissible wear or deformation is visible.

The spacing requirements stipulated in IEC 60601-2-52:2009/AMD:2015 are used for level of protection check. This is shown schematically in the following figures and the table.



Fig. 1 (dimensions of a single-piece side rail)

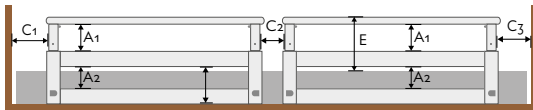
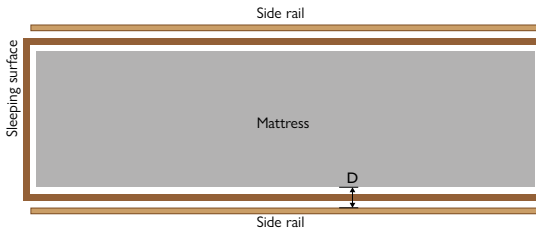

Fig. 2 (dimensions of a split side rail)



Check whether the required distances are also complied with under load. Dimensions A and C must be checked with a test tool in accordance with IEC 60601-2-52:2009/AMD:2015. The test force for dimension A is 250 N.

Dimensions		Requirement
A1	Fully enclosed opening within the side rail	< 120 mm
A2	Fully enclosed opening resulting from the arrangement of the side rail, its supports and the sleeping surface in relation to each other	< 120 mm
B	Distance between sleeping surface and the lowest point of the side rail on the outside of the rail support	< 60 mm
C1	Distance between head section and neighbouring side rail	< 60 mm
C2	Opening between segmented or split side rails	< 60 mm or > 318 mm
C3	Opening between side rail and foot section	< 60 mm or > 318 mm
D	Area between side rail and mattress.	according to check conditions Standard
E	Height of the upper edge of the side rail to the upper edge of the mattress, resulting in the thickness of the mattress used (without compression, as specified by the manufacturer). with VGS side rail version with GS side rail version with DS side rail version	≥ 220 mm 12 - 16 cm* 12 - 15 cm* 12 - 15 cm*

* only applies for ABS and metal grid sleeping surface. When using the comfort sleeping surface, a maximum mattress height of 12 cm is permissible.

STORAGE

The following steps must be taken when the hospital beds are being put into storage.

- ⚠ Move the bed to its lowest position.
- ⚠ Remove any accessories such as bed lamps, lifting poles etc.
- ⚠ Cover hospital beds in such a way that the head/foot boards and the frame cannot be damaged.
- ⚠ To ensure the necessary, regular maintenance intervals, attach the storage date to the bed in a visible location



Caution! The same conditions apply to the storage location of hospital beds as to the working environment. (temperature, humidity, heat, etc.)



The manufacturer's transport aid must be used to transport the beds.

WARRANTY AND SERVICE

By purchasing a hospital bed from Malsch GmbH, you have chosen a premium, high-quality product.

Malsch hospital beds are covered by a 24-month warranty calculated from the date of purchase.

In the event of material or manufacturing faults occurring within the warranty period, the bed will be replaced or repaired free of charge.

This excludes faults and errors caused by inappropriate handling or external influences.

Our normal terms of business and delivery apply.



If you have any questions, please contact us on the following numbers:

Customer service

Phone: +49 (0) 6626 915 100
Fax: +49 (0) 6626 915 127

info@bettenmalsch.de
bettenmalsch.com

DECLARATION OF CONFORMITY

 robust award 2016 winner	 GERMAN DESIGN AWARD 2018	
DE	EN	
EU-Konformitätserklärung	EC Declaration of Conformity	
nach der Verordnung (EU) 2017/745 des europäischen Parlaments und des Rates vom 5. April 2017 über Medizinprodukte, Anhang IV	according to Regulation (EU) 2017/745 of the European Parliament and of the Council of 5 April 2017 concerning medical devices, Ann. IV	
Der Hersteller Malsch GmbH Rohbergstraße 9, 36208 Wildeck Tel: +49 (0) 6626 915 100 SRN DE-MF-000005173	The manufacturer Malsch GmbH Rohbergstraße 9, 36208 Wildeck, Germany Phone +49 (0) 6626 915 100 SRN DE-MF-000005173	
erklärt in alleiniger Verantwortung, dass die nachfolgend benannten Produkte den grundlegenden Anforderungen und Bestimmungen der Verordnung (EU) 2017/745 für Medizinprodukte entsprechen und gemäß der Anhänge II, III und VIII, Regel (1) der Risikoanalyse I zugeordnet werden:	declares under its sole responsibility that the devices named below comply with the essential requirements and provisions of Regulation (EU) 2017/745 for medical devices and are assigned to risk class I in accordance with Annexes II, III and VIII (Rule 1)	
Klinikbett IMPULSE KL-M	Hospital bed IMPULSE KL-M	
Basis UDI-DR: 4065848MALSCH-PKL00008Z	Basis UDI-DR: 4065848MALSCH-PKL00008Z	
Die bezeichneten Produkte wurden unter Anwendung der folgenden Richtlinien und harmonisierten Normen produziert:	The designated products have been produced in application of the following directives and harmonised standards	
Mechanische Sicherheit: IEC 60601-2-52:2009+A1:2015	Mechanical safety: IEC 60601-2-52:2009+A1:2015	
Gebrauchstauglichkeit: IEC 62366-1:2015+COR1:2016	Usability: IEC 62366-1:2015+COR1:2016	
Risikomanagement: DIN EN ISO 14971:2022-04	Risk Management: DIN EN ISO 14971:2022-04	
Durch die Einhaltung der Bestimmungen der Verordnung (EU) 2017/745 werden die Anforderungen zur Anbringung einer CE-Kennzeichnung erfüllt. Aufgrund der Spezifikation als Medizinprodukt Klasse I werden Produkt und Verpackung spätestens ab Mai 2025 zusätzlich mit einer UDI-Kennzeichnung versehen. Eine Konformität der Produkts- und Entwicklungsdokumentation sowie des QMS-Systems wird durch die Zertifizierung nach DIN EN ISO 13485:2021 bestätigt.	By complying with the provisions of Regulation (EU) 2017/745, the requirements for affixing a CE marking are fulfilled. Due to the specification as a medical device class I, the product and packaging will additionally be provided with a UDI marking from May 2025 at the latest. Conformity of the product and development documentation as well as the QMS system is confirmed by certification according to DIN EN ISO 13485:2021.	
Bei einer mit uns nicht abgestimmten Änderung des oben genannten Produktes verliert diese Erklärung ihre Gültigkeit.	In the event of a modification of the above-mentioned product not agreed with us, this declaration loses its validity.	
 Ralf Malsch Geschäftsführer / CEO / Owner		
Wildeck, den 28.05.2024		
info@bettenmalsch.de		

CERTIFICATES

ZERTIFIKAT

für das Managementsystem nach
EN ISO 13485:2016/AC:2018,
EN ISO 13485:2016/A11:2021
Der Nachweis der regelkonformen Anwendung wurde erbracht.

Zertifikat-Registrier-Nr.:
73 105 1297
Gültig vom:
2022-11-17 bis: 2025-07-10

Malsch
care & clinical design
Malsch GmbH
Robbergstraße 9
36208 Wildeck - Obersuhl / Deutschland

Geltungsbereich - für den Tätigkeitsbereich Wirtschaftszweig:
Entwicklung, Herstellung, Vertrieb und Service von Kranken- und Pflegebettsystemen, sowie zugehörige Beratungsleistungen insbesondere Objektplanung und Ausstattung im Medizinischen Umfeld.

IAF
DAKKS
Zertifizierungsstelle
für Medizin

Dr. Panitzke

Logo and QR code area

ZERTIFIKAT

für das Managementsystem nach
DIN EN ISO 9001:2015
Der Nachweis der regelkonformen Anwendung wurde erbracht.

Malsch
care & clinical design
Malsch GmbH
Robbergstraße 9
D-36208 Wildeck - Obersuhl

Geltungsbereich:
Entwicklung, Herstellung und Vertrieb von
Kranken- und Pflegebettsystemen, Objektausstattung

Zertifikat-Registrier-Nr. 73 105 1297 **Zertifikat gültig von 2022-10-01 bis 2025-09-30**
Auditorische Nr. 4404 1931 **Erstzertifizierung 2006-07-21**

IAF **DAKKS**

ZERTIFIKAT

für das Managementsystem nach
DIN EN ISO 14001:2015
Der Nachweis der regelkonformen Anwendung wurde erbracht.

Malsch
care & clinical design
Malsch GmbH
Robbergstraße 9
D-36208 Wildeck - Obersuhl

Geltungsbereich:
Entwicklung, Herstellung und Vertrieb von
Kranken- und Pflegebettsystemen, Objektausstattung

Zertifikat-Registrier-Nr. 73 104 1297 **Zertifikat gültig von 2022-10-01 bis 2025-09-30**
Auditorische Nr. 4404 1931 **Erstzertifizierung 2013-10-01**

IAF **DAKKS**

NOTES

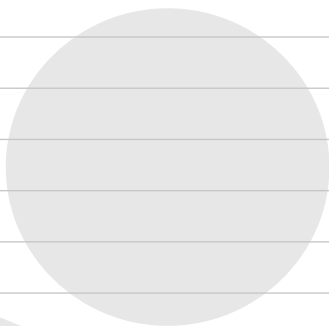

NOTES

Item No. 91300 103102.0.1
EN, Updated 10/2024, Rev. 2.0.1
Colours may vary

Subject to technical changes

Malsch GmbH | Rohbergstraße 9 | 36208 Wildeck-Obersuhl | Germany
Tel.: +49 (0) 6626 915 100 | Fax: +49 (0) 6626 915 116
bettenmalsch.com | info@bettenmalsch.de

