



CARE DESIGN

CARE BEDS INSTRUCTION MANUAL

IMPULSE | AURA





Dear Customers,

By purchasing a care bed from Malsch care & clinic design<sup>®</sup>, you have obtained a long-lasting medical device with functions that meet all the requirements of everyday care while maintaining the highest safety standards.

Thank you very much for the trust you have placed in us.

Our company guarantees carefully selected materials and continuous quality control while employing state-of-the-art production technologies.

Complying with the usage and operating instructions helps to prevent the risk of accidents and preserves the high value of your care bed.

# CONTENTS

IMPULSE care bed product range	6	Reference movements using JCH-35A6 hand controller	27
AURA care bed product range	7	Function illustration	28
Specific function	8	IMPULSE care bed with undercarriage Edition 400	28
Environmental sustainability	8	IMPULSE care bed with undercarriage Edition 400 ZB	29
Note on the instruction manual	9	IMPULSE care bed with undercarriage Edition 400 LR	30
Pictograms/symbols	9	IMPULSE care bed with undercarriage Edition 420	31
Safety instructions	10	IMPULSE care bed with undercarriage Edition 420 LR	32
IMPULSE care bed technical data	14	IMPULSE care bed with undercarriage Edition 500	33
IMPULSE care bed electrical drives	15	IMPULSE care bed with undercarriage Edition XL	34
AURA care bed technical data	16	AURA care bed	35
AURA care bed electrical drives	17	AURALR care bed	36
Rating plate with UDI	18	Description of function	38
9-button hand controller (JCH-35A6 3-motor)	22	Back rest	38
12-button hand controller (JCH-35A6 4-motor)	23	Mechanical back rest release/CPR	38
HB-400 hand controller symbols	24	Adjustable thigh/lower leg rest	39
HB-400 hand controller symbols (8-button version)	25	Auto contour	39
Reference movements using HB-400 hand controller	26	Height adjustment	39

Transfer position	40	Disposal instructions	60
Low position/fall prevention	40	Accessories	61
Trendelenburg position	40	Lifting pole	61
Reverse Trendelenburg position	41	IV drip holder	61
Automatic chair position	41	Bedside light	61
Hand controller locking function	42	Hand control holder	62
Braking and moving	43	Integrated bed linen holder	62
Adjust DS side rails	46	Troubleshooting	63
Adjustment of side rails GS	48	Product safety	64
Adjustment of side rails VGS	50	Cleaning and disinfection	65
Adjustment of side rails EVGS	51	Safe decommissioning/storage	66
VGS side rail dimensions	52	Electromagnetic compatibility (EMC)	67
Different lengths of the GS and VGS side rails	53	Warranty and service	70
Integrated bed extension	54	Customer service	70
Maintenance	56	Declaration of conformity	70
Maintenance intervals	58	Certificates	71
Delivery and assembly	59		

## IMPULSE CARE BED PRODUCT RANGE



IMPULSE care bed with undercarriage  
Edition 400



IMPULSE care bed with undercarriage  
Edition 400ZB



IMPULSE care bed with undercarriage  
Edition 400LR



IMPULSE care bed with undercarriage  
Edition 420



IMPULSE care bed with undercarriage  
Edition 420LR



IMPULSE care bed with undercarriage  
Edition 500



IMPULSE care bed with undercarriage  
Edition XL

## AURA CARE BED PRODUCT RANGE



AURA care bed



AURA LR care bed

## SPECIFIC FUNCTION

The care beds made by Malsch GmbH are used in the care industry for patients with physical limitations. The beds are designed exclusively for this purpose. The functions of these care beds assist the care staff in their daily work and offer convenient solutions for positioning the patient and compensating for certain symptoms experienced by patients of retirement and care homes or comparable medical facilities. This complies with working environment 3 and 5 as stipulated by IEC 60601-2-52:2009/AMD1:2015.

**Prior written consent from Malsch GmbH is required if the care beds are to be used for other applications.**

The product is intended for use as a care aid or health device. As such, it is subject to the regulations of the relevant insurance associations. The care bed is a medical device with reference to applicable industry standards and regulations. Therefore, this product must only be used under medical supervision.

The care beds described in this instruction manual are intended for adult residents with a body weight of at least 40 kg and a height of at least 146 cm. In accordance with standard IEC 60601-2-52:2009/AMD1:2015, the beds must not be used by residents whose body weight and height are below these limits or who have a BMI under 17, as the risk of injury is increased for this group.



---

Caution! The use of incompatible side rails and mattresses can lead to injury as body parts may become trapped.

---

## ENVIRONMENTAL SUSTAINABILITY

Malsch GmbH care beds are manufactured in line with the relevant regulations using state-of-the-art processing technologies, and contain no hazardous materials. The materials used to finish surfaces are CFC- and solvent-free.

Care beds that are taken out of service due to their age or irreparable damage must be disposed of in line with local disposal regulations.



---

Caution! Please observe the relevant local regulations when disposing of metal, wood and electrical waste.

---



## NOTE ON THE INSTRUCTION MANUAL

The following directions and statutory requirements in this instruction manual are intended for care staff or other persons and staff tasked with operating and using the care bed.



---

The instruction manual must be accessible to personnel at all times to avoid operating errors and to guarantee fault-free operation. The care staff must have a good understanding of the care beds and be trained in their operation before using them for the first time. The instruction manual must be used for this training.

---

The instruction manual has been written for the IMPULSE and AURA care beds. The images, graphics and texts it contains may differ from the equipment supplied.



---

The manufacturer offers technician training for maintenance and servicing work on their care beds. A certificate obtained as part of this training authorises the holder to carry out technical work independently on the beds.

---

## PICTOGRAMS / SYMBOLS

For better orientation, this instruction manual uses the pictograms described below.



### Important!

Instructions labelled in this way must be strictly observed in order to avoid injury or damage!



### Information!

This symbol marks relevant information in its respective context.

# SAFETY INSTRUCTIONS

It is important that the following safety instructions are observed to prevent risks to residents as well as carers, and to avoid any damage to the bed:

- ⚠ The instruction manual must be read and observed before using the care bed.
- ⚠ It is vital to observe the information given on the rating plate! The information given on the rating plate is explained in detail on *☞ P. 18* of this instruction manual.
- ⚠ In the event of any faults or defects that could endanger a person, the bed must not be used.
- ⚠ Electrically-adjustable care beds must only be operated by the resident after instruction by trained staff.
- ⚠ Before the bed is used for the first time, the operator must be satisfied that it is safe to use and in good condition.
- ⚠ The castors must always be placed in the braked position to ensure the resident does not fall when getting into or out of the bed.
- ⚠ The bed can be moved into various positions. When doing so, please ensure that no objects or parts of the body are located in the adjustment area.
- ⚠ Only care staff may adjust the side rails. When adjusting the sleeping surface position, take care to ensure the residents do not come into contact with the side rails to avoid trapping any part of the body.
- ⚠ The functionality of the side rails must be checked every day. They must not bear any load of over 75 kg vertically or over 50 kg horizontally.
- ⚠ When using CPR (optional, mechanical emergency lowering of the back rest), always additionally relieve the load on the back rest manually to prevent it from dropping in an uncontrolled manner.
- ⚠ The hand controller functions can be locked or released using the magnetic chip (*☞ P. 22 Hand controller symbols*) on the front. The effectiveness of the locking function must be checked using the hand controller.
- ⚠ The drive system used must be operated using a VDE-approved power source – 100-240 V, 50/60 Hz mains socket.
- ⚠ The mains connection cable must also be protected by a mechanical strain relief device. Nevertheless, take care to ensure that the cable is not damaged by sharp edges, mechanical loads or pinch/shear points.
- ⚠ The hand controller can be routed flexibly. When positioning the hand controller, take care to ensure that it cannot be triggered accidentally (e.g. by being trapped between two objects). The hand controller must be freely accessible.
- ⚠ The cable of the hand controller is usually on the right-hand side of the bed from the occupant's perspective, and attached to the underside of the sleeping surface with a strain relief. The use of the hand controller on a different side of the bed leads to over-stretching of the cable, which can

result in damage such as breakage of the cable sheath or the wires inside the sheath. In a case such as this, the power supply of the bed must be disconnected from the mains and the hand controller replaced immediately. Otherwise there is a risk of electric shock.

In order to avoid potential damage and ensure that safe and efficient operation takes place, the following information regarding the positioning of the hand controller must be observed:

- The cable of the hand controller must always be inserted into the strain relief at the side of the bed on which it is used.
- It must be ensured that the cable is not over-stretched when the hand controller is fitted. Proper cable routing is required in order to avoid damage.
- The hand controller and the cable must be checked for signs of wear or damage at regular intervals. In the event of abnormalities, the bed must be disconnected from the mains immediately, and customer service must be contacted.

 Observe safety distances to walls, window ledges and other furnishings when using the care bed in a resident's room. The safety distances depend on the design and model of the care bed and are based on the height adjustment and the tilting motions of the bed. The minimum distance is 30 mm.

 Improper use of the bed may cause hazards. Examples of improper use include:

- Unauthorised activation of the electrical functions
- Use of the bed by persons with a body weight of less than 40 kg or a BMI of less than 17 or a height of less than 146 cm. *☞ P. 8 Specific function*
- Exceeding the permissible working load
- Moving the bed by pulling on the mains cable or side rails
- More than one person adjusting the bed at the same time
- Activation of the functions by the resident without prior instruction
- Pulling the mains cable to disconnect it from the power supply
- Moving the bed on sloping or unsurfaced ground

 In accordance with IEC 60601-2-52:2009/AMD:2015, when choosing a mattress, it is important that there is a minimum distance of 22 cm between the top of the sleeping surface and the top of the side rail in its fully extended position. The mattress that is used must fulfil the applicable safety standards.

 The constant presence of liquid in the vicinity of the motor must be avoided (e.g. incontinence).

 For safety reasons, the grab handle on the lifting pole must be replaced completely every 5 years.

- ⚠ Servicing and repairs on electrical components must be carried out by specially trained staff, and only original replacement parts from the manufacturer may be used.
- ⚠ The care bed is not suitable for extended operation beyond a working cycle of 2 minutes. If the mains adapter is overloaded or overheats, it will shut off automatically. Further operation is possible only after a 30-minute cool-down phase. (Observe the drive manufacturer's notes on the rating plate!)
- ⚠ It is essential to avoid obstructing any part of the bed mechanism, since this can lead to damage or complete disabling of the drive system due to overheating.
- ⚠ Likewise, the safe working load must not be exceeded.
- ⚠ If an immobile resident remains in the same position for an extended period of time without the use of additional positioning aids, this can lead to pressure sores. The manufacturer of the care bed is not liable for this in any way.
- ⚠ Electrically operated care beds are active medical devices and must be maintained according to Article 7 of the German Medical Device Operator Ordinance (MedProd-BetrV). These maintenance measures must be carried out regularly (at least once per year). The visual and operational inspections of functional and electrical safety in accordance with IEC 62353:2014 (VDE 0751-1) must be performed when this takes place. *☞ P. 56 Maintenance*
- ⚠ Furthermore, electrically operated care beds are electrical appliances and their safety is the responsibility of the em-

ployer. The supervisory function of this obligation is the responsibility of the Employers' Liability Insurance Association for Health Service and Welfare Work (BGW) and the Trade Supervisory Board (Gewerbeaufsichtsamt). The regulations of the employers' liability insurance associations apply, particularly those of the German statutory accident insurance body (DGUV), rule 3 of which stipulates regular inspections of movable electrical equipment at a recommended interval of six months, but at least once a year. These inspections may only be carried out by a certified electrician or person with electrical training using specialist measurement and inspection equipment. The inspections according to DGUV rule 3 can be conducted by specialist staff trained by the manufacturer as part of the inspections and maintenance service for medical devices.

- ⚠ Electrically operated care beds are active medical devices and must be listed in an inventory for each site in line with Article 13 of the German Medical Device Operator Ordinance (MedProd-BetrV). It is advisable to also document the correct implementation of the required checks and servicing in this inventory and to specify the date of the next inspection. The required protocols concerning checks which have already been performed must be appended to the inventory.
- ⚠ Proper execution and traceable documentation of the technical checks, maintenance and servicing work prescribed by the manufacturer, as well as the technical safety checks, are required in order to preserve the warranty rights of the purchaser. If the operator of a medical device does not fulfil their obligations, this could lead to the risk of damage and accidents for which the manufacturer is explicitly not liable.

- ⚠ Maintenance work must be carried out and documented by trained staff.
- ⚠ The bed must be left in the lowest position if the resident is unattended in order to reduce the risk of injury caused by falling out of bed.
- ⚠ If the mains connection cable is damaged, the bed can no longer be used and must immediately be taken out of operation.
- ⚠ Improper use of the mains connection cable can result in hazards (e.g. electric shock). Examples of this are cable breaks due to kinking, shearing or other mechanical damage.
- ⚠ When using other ME devices in conjunction with the care bed, precautions must be taken to prevent damage to the device cable or other components of the ME device resulting from crushing between the movable parts of the medically used bed.
- ⚠ The care bed is not suitable for use in the vicinity of active facilities that use high-frequency surgical devices.
- ⚠ The care bed is not suitable for use in HF-shielded rooms used for magnetic resonance imaging in which high-intensity EM disturbance variables occur.
- ⚠ The use of this care bed directly next to or in conjunction with other electrical devices (e.g. stacked) must be avoided, since this can lead to faulty operation. If use of the bed in the manner described above is absolutely necessary, the devices involved should be subjected to a function test for a

longer period of time in order to rule out malfunction due to interference.

- ⚠ The use of accessories, transducers and cables other than those specified or provided by Malsch GmbH can cause increased emissions of electromagnetic interference or reduce the electromagnetic interference resistance of the device and thus lead to faulty operation.
- ⚠ Portable HF communication devices (radio devices) – including their accessories, such as antenna cables and external antennas – must not be used closer than 30 cm to the parts and cables of care beds as designated by Malsch GmbH. Non-observance can impair the performance of the care bed.
- ⚠ The emissions of this device are below the thresholds defined by IEC/CISPR 11:2009, Class A and thus permit the use thereof in industrial environments and hospitals. This device may not provide adequate protection against wireless services if used in residential areas (for which Class B is normally required according to CISPR 11). The user may have to implement remedial measures such as relocating or repositioning the device.
- ⚠ Servicing and maintenance tasks may not be performed while the ME device is in use.
- ⚠ The care bed must be positioned so that it does not obstruct anyone from disconnecting the mains plug.

## IMPULSE CARE BED TECHNICAL DATA

Model	Dimensions [cm]	Sleeping surface [cm]	Height adjustment [cm] <sup>1</sup>	Weight	Safe working load	Reverse / Trendelenburg position	Thigh rest adjustment	Back rest adjustment
IMPULSE care bed with undercarriage Editions 400 / 400 ZB	100 x 206	90 x 200	25 to 82	Approx. 120 kg	Total 225 kg 190 kg resident 20 kg mattress 15 kg accessories	17° / 14°	33°	71° / 12 cm Mattress compensation
	90 x 174,5	80 x 168,5						
	90 x 186	80 x 180						
	90 x 196	80 x 190						
	100 x 196	90 x 190						
	90 x 206	80 x 200						
	110 x 206	100 x 200						
	120 x 206	110 x 200						
IMPULSE care bed with undercarriage Edition 400 LR	100 x 206	90 x 200	26 to 82	Approx. 120 kg	Total 225 kg 190 kg resident 20 kg mattress 15 kg accessories	17° / 14°	33°	71° / 12 cm Mattress compensation
	110 x 206	100 x 200						
IMPULSE care bed with undercarriage Edition 420	100 x 206	90 x 200	27 to 80	Approx. 100 kg	Total 200 kg 165 kg resident 20 kg mattress 15 kg accessories	-	30°	71° / 12 cm Mattress compensation
	90 x 206	80 x 200						
	110 x 206	100 x 200						
IMPULSE care bed with undercarriage Edition 420 LR	100 x 206	90 x 200	28 to 81	Approx. 84 kg	Total 200 kg 165 kg resident 20 kg mattress 15 kg accessories	-	30°	71° / 12 cm Mattress compensation
	90 x 206	80 x 200						
	110 x 206	100 x 200						
IMPULSE care bed with undercarriage Edition 500	100 x 206	90 x 200	15 to 75	Approx. 136 kg	Total 200 kg 165 kg resident 20 kg mattress 15 kg accessories	17° / 14°	33°	71° / 12 cm Mattress compensation
	110 x 206	100 x 200						
IMPULSE care bed with undercarriage Edition XL	110 x 206	100 x 200	33 to 83	Approx. 160 kg	Total 300 kg 250 kg resident 25 kg mattress 25 kg accessories	17° / 14°	33°	71° / 12 cm Mattress compensation
	110 x 226	100 x 220						
	130 x 206	120 x 200						

## IMPULSE CARE BED ELECTRICAL DRIVES

Model	Edition 400 Edition 400 ZB Edition 400 LR	Edition 420 Edition 420 LR	Edition 400 Edition 400 ZB Edition 400 LR	Edition 420 Edition 420 LR Edition XL	Edition 500
Hand controller version	JCH-35A6	JCH-35A6	HB-400	HB-400	HB-400
Electrical connection	100–240 V AC 50/60 Hz		100–240 V AC 50/60 Hz		
Output voltage	32 V DC 5 A		–	–	–
Over-current off	7 A	7.5 A	–	–	–
Over-voltage off	–	–	–	–	–
Standby operation	≤ 1 W		Max. 0.8 W		
Drive protection class	IPX 4		IPX 4		
Control box protection class	IPX 6		–		
Hand controller protection class	IPX 4		–		
Protection class	II		II		
Lifting system force					
Lifting system force	2 × 6000 N	1 × 8000 N	2 × 6000 N	2 × 6000 N	2 × 8000 N
Sleeping surface adjustment force	2 × 4000 N	2 × 4000 N	2 × 3000 N	2 × 3000 N	Head 6000 N Foot 3000 N
Motor running time	on 2 min./off 18 min. 25° C		on 2 max./off 18 min.		
Data on operation, transport and storage					
Operating temperature range	+5° C to +40° C		+5° C to +40° C		
Transport/storage temperature range	-10° C to +50° C		-10° C to +50° C		
Relative humidity	20% to 90%, non-condensing		20% to 80%		
Drive atmospheric pressure range	700 hPa to 1060 hPa		700 hPa to 1,060 hPa		
Atmospheric pressure range Control box and hand controller	860 hPa to 1060 hPa		–		
Operating volume	–		54 dB (A)		
Operating altitude	Max. 2,000 m		Max. 3,000 m		

## AURA CARE BED TECHNICAL DATA

Model	Dimensions [cm]	Sleeping surface [cm]	Height adjustment [cm] <sup>1</sup>	Weight	Safe working load	Reverse/Trendelenburg position	Thigh rest adjustment	Back rest adjustment
AURA AURA LR	92.5×206	80×200	Approx. 25 (26 <sup>2</sup> ) to 82	Approx. 130 kg	Total 225 kg 190 kg resident 20 kg mattress 15 kg accessories	17°/14°	33°	71°/12cm Mattress compensation
	102.5×206	90×200		Approx. 140 kg				
	112.5×206	100×200		Approx. 150 kg				
	122.5×206	110×200		Approx. 160 kg				
	132.5×206	120×200		Approx. 170 kg				

<sup>1</sup> measured from sleeping surface frame

<sup>2</sup> AURA LR



## AURA CARE BED ELECTRICAL DRIVES

Model	AURA AURA LR	AURA AURA LR
Hand controller version	JCH-35A6	HB-400
Electrical connection	100–240 V AC 50/60 Hz	100–240 V AC 50/60 Hz
Output voltage	32 V DC 5 A	–
Over-current off	7 A	–
Over-voltage off	–	–
Standby operation	≤1 W	Max. 0.8 W
Drive protection class	IPX4	IPX4
Control box protection class	IPX6	–
Hand controller protection class	IPX4	–
Protection class	II	II
Lifting system force		
Lifting system force	2 x 6000 N	2 x 6000 N
Sleeping surface adjustment force	2 x 4000 N	2 x 3000 N
Motor running time	on 2 min./off 18 min. 25° C	on 2 min./off 18 min. 25° C
Data on operation, transport and storage		
Operating temperature range	+5° C to +40° C	+5° C to +40° C
Transport/storage temperature range	-10° C to +50° C	-10° C to +50° C
Relative humidity	20% to 90%, non-condensing	20% to 80%
Drive atmospheric pressure range	700 hPa to 1060 hPa	700 hPa to 1,060 hPa
Atmospheric pressure range Control box and hand controller	860 hPa to 1060 hPa	–
Operating volume	–	54 dB (A)
Operating altitude	Max. 2,000 m	Max. 3,000 m

# RATING PLATE WITH UDI

**1**  Malsch GmbH | Rohbergstraße 9 | 36208 Wildeck-Obersuhl | Germany  
Tel.: +49 (0) 6626 915-100 | info@bettenmalsch.de | bettenmalsch.com



**2** REF Care bed **IMPULSE**

UDI  **10**



**3** SN (01)4065848000014 **11**  
(21)112440001234567

**4** Input: 100 - 240 V AC 50 / 60 Hz  
Output: 32 V DC 5 A

**5** Operation: max. T\_on 2 min  
max. T\_off 18 min

**6** Protection: IPX4









**7** Next inspection:  
11/2025

**9**  180 kg  190 kg

 345 kg

R 4.0

Made in Germany



**8**        





Example illustration of a rating plate with UDI of the IMPULSE care bed with the Jiechang 12-button hand controller

The rating plate is located on the underside of the sleeping surface, at the head of the bed on the right. To inspect the rating plate, raise the back rest to the highest position.



Notes:

1. Manufacturer's address
2. Model ID
3. Serial number
4. Electrical voltage; Frequency; Power consumption
5. Operating time of motorised adjustment: Please observe this information to protect against overheating! In the example, the drives of the bed are limited to a maximum of 2 minutes of continuous operation. If this limit is reached, a regeneration period of 18 minutes must be observed before the drives can be operated again.
6. Protection of electrical equipment from water spray "only use in dry areas"
7. Indicates the next technical check after delivery in line with VDE0751-1
8. Explanation of the safety symbols used on the rating plate:

	Labelling as a medical device
	Application part type B

	Directive 2012/19/EU relating to old electrical and electronic equipment
	Conformity marking in line with the Medical Device Directive (EU) 2017//745
	Protection class II
	"Only use in dry areas"
	"Observe the instruction manual"

9. Explanation of the weight icons used on the rating plate:

	Safe working load
	Maximum permissible weight of residents
	Maximum total weight of the medical device incl resident (bed weight plus maximum safe work load)

10. 2D barcode (GS1 data matrix) DI+PI = UDI

11. (DI) Device Identifier  
(01) UDI-DI/GTIN  
(PI) Production Identifier  
(21) Serial number

## Labels

A separate sticker to the right of the rating plate refers to the labels described below:

Symbol: Label indicating beds for adults used for medical purposes in line with IEC 60601-2-52:2009/AMD:2015

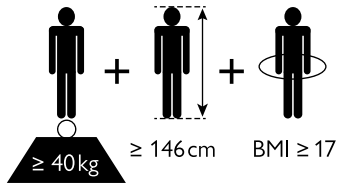

The care bed is approved for adult residents with a body weight of at least 40kg and a height of at least 146cm. In accordance with standard IEC 60601-2-52:2009/AMD1:2015, the care bed must not be used by residents whose body weight and height are below these limits or who have a BMI under 17, as the risk of injury is increased for this group.

Symbol: Label indicating replaceable mattresses in line with IEC 60601-2-52:2009/AMD:2015 – please observe the information and instruction manual for the mattresses!

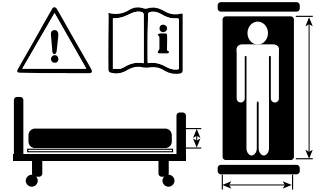

The following table contains information concerning mattress sizes depending on the sleeping surface dimensions:

Mattress size [cm]	Sleeping surface dimensions [cm]	Volumetric weight [kg/m <sup>3</sup> ]
78×200×12/14	80×200*	35-50
88×200×12/14	90×200	35-50
98×200×12/14	100×200*	35-50
108×200×12/14	110×200*	35-50
118×200×12/14	120×200*	35-50

\* Optional special sizes



# 9-BUTTON HAND CONTROLLER (JCH-35A6 3-MOTOR)

IMPULSE care bed Edition 420/420LR

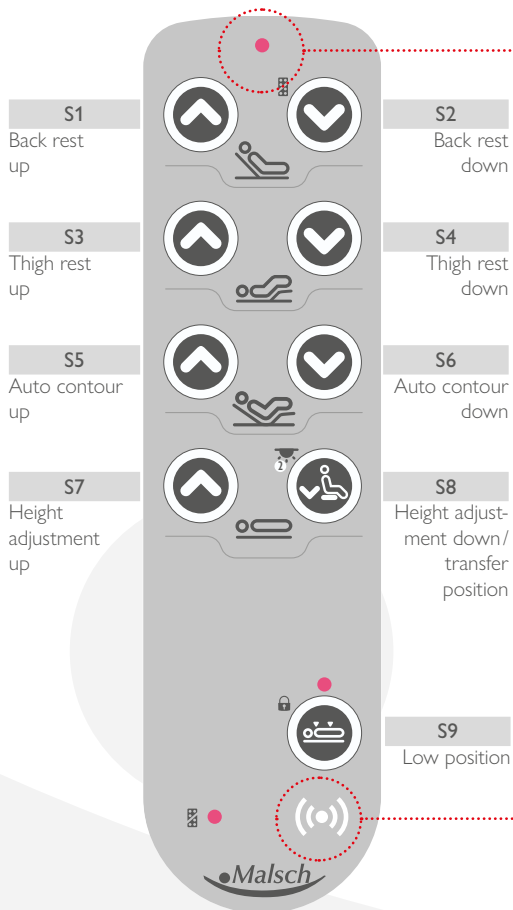



The function lamp indicates that a button has been pressed

## Locking functions

via magnetic chip to restrict operation by residents. The LED next to the lock symbol illuminates if the button lock has been activated.  
 ↗ P. 42 Operating the JCH-35A6 hand controller locking function



Button	Locking
S2 	All functions
S9 	Low position
<b>Other functions</b>	
S8 	Orientation light (double button press)

Contact surface for the magnetic chip for activating/deactivating the locking functions

# 12-BUTTON HAND CONTROLLER (JCH-35A6 4-MOTOR)

Care bed **IMPULSE Edition 400/400LR/400ZB**, Care bed **AURA/AURALR**

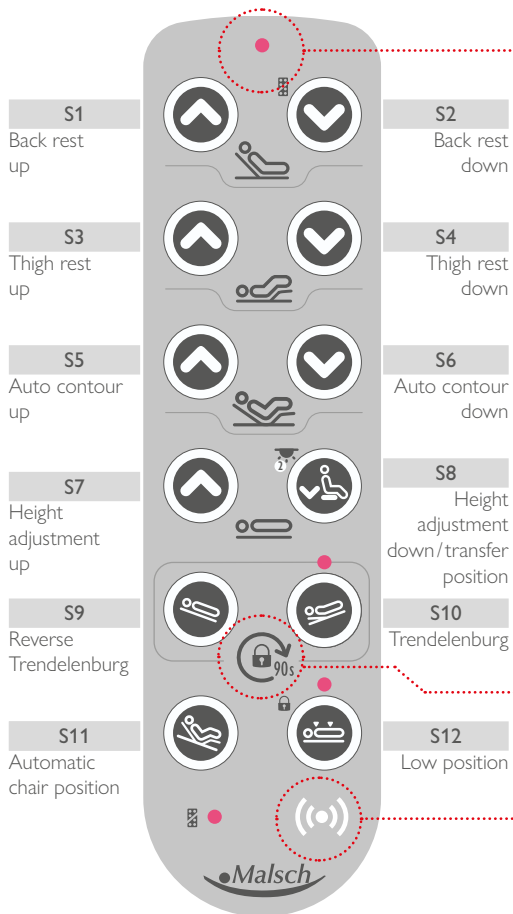





The function lamp indicates that a button has been pressed

## Locking functions

via magnetic chip to restrict operation by residents. The LED next to the lock symbol illuminates if the button lock has been activated.  
 P. 42 Operating the JCH-35A6 hand controller locking function



Button	Locking
S2 	All functions
S9 	Low position
<b>Other functions</b>	
S8  	Orientation light (double button press)

The Trendelenburg/reverse Trendelenburg position is automatically locked after 90 seconds of inactivity. Enabling for 90 seconds takes place by placing the magnetic chip onto the contact surface.

Contact surface for the magnetic chip for activating/deactivating the locking functions

# HB-400 HAND CONTROLLER SYMBOLS

IMPULSE care bed Edition 400/400LR/400ZB/500/XL<sup>1</sup>  
 AURA/AURA LR care bed

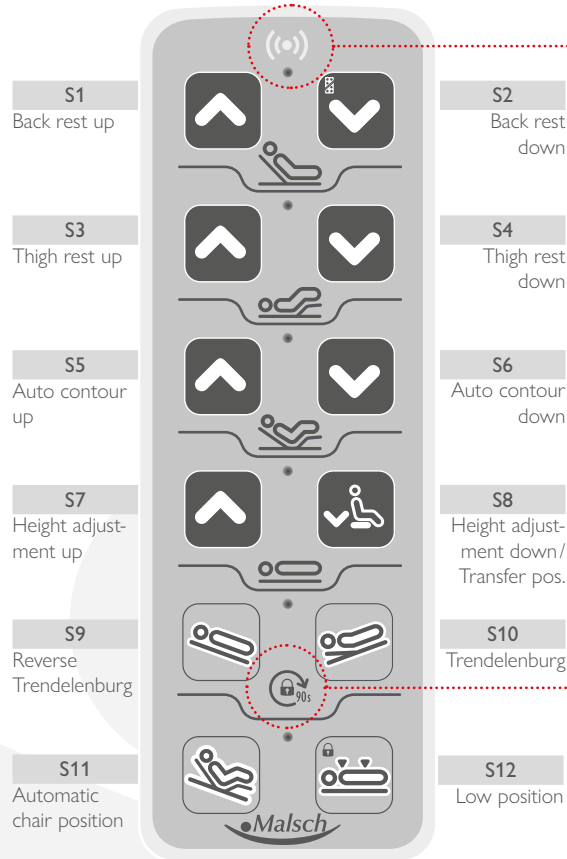

## Locking functions

via magnetic chip to restrict operation by residents.  
 ↪ P. 42 Operating hand controller locking function HB-400



Button	Locking
S2	All functions
S10	Trendelenburg position
S12	Low position

The Trendelenburg/reverse Trendelenburg position is automatically locked after 90 seconds of inactivity. Enabling for 90 seconds takes place by placing the magnetic chip onto the contact surface.



# HB-400 HAND CONTROLLER SYMBOLS (8-BUTTON VERSION)

IMPULSE care bed Edition 420/420LR/AURA (optional)

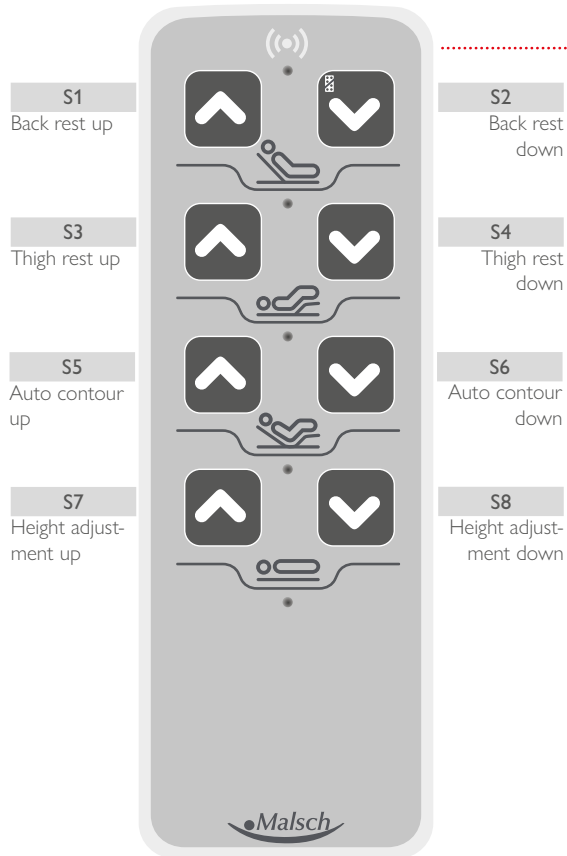

## Locking functions

via magnetic chip to restrict operation by residents.  
 ↪ P. 42 Operating hand controller locking function HB-400



Button	Locking
S2 	All functions

# Reference movements using HB-400 hand controller

## Initialisation

When using the system for the first time, an initialisation of all the drives is performed as part of quality control at the factory.

To rerun initialisation during the course of maintenance or with a fault, all drives should be completely retracted as described in the following:

**S2 button:** Retract the head-side sleeping surface drive

**S4 button:** Retract the foot-side sleeping surface drive

The initialisation of the lifting motors requires “manual mode” to be activated, see below. The drives can then be gradually retracted (max. 10mm/keystroke) until they reach the end point

**S1 button:** Retract the head-side lifting motors

**S2 button:** Retract the foot-side lifting motors

## Manual mode

To activate manual mode, press down **buttons S1 and S2** on the hand controller at the same time for approx. 5 seconds until the acoustic signal intervals slow down. Manual mode is now active.

Repeatedly pressing **button S1** gradually retracts the head-side lifting motor 10mm each time the button is pressed.

Repeat the process until the lifting motor has reached its lowest position. Then press **button S2** to repeat the process for the foot-side lifting motor.

Manual mode ends automatically when no button has been pressed for 10 seconds.

## Fatal error reset

In the event of a fault, the software automatically issues a “fatal error”. This means that functions may be restricted or unavailable in certain situations. This fault can be reset using a fatal error reset,

which is activated by pressing down **buttons S3 and S4** for 5 seconds at the same time. If a fatal error occurs, this re-initialises the system (a fatal error reset is performed).

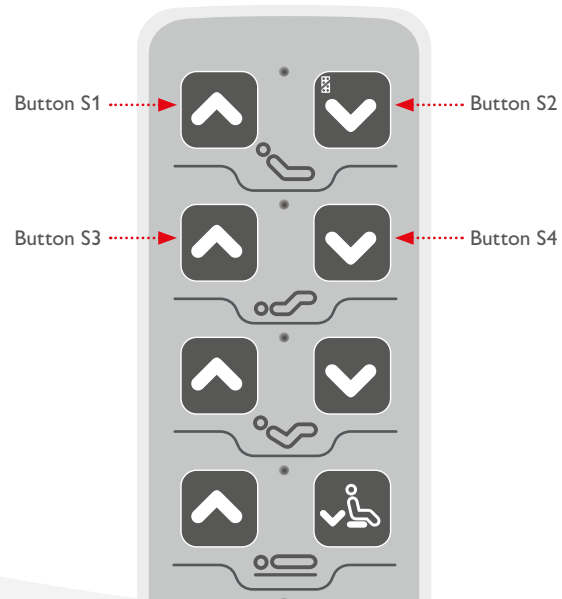

## Reference movements using JCH-35A6 hand controller

In the event of a fault, the system may need to be reset.

To do this, **buttons S1 and S2** must be pressed and held down simultaneously for 5 seconds. When the system reset is complete (green LED flashes 3x), an automatic reference movement is carried out.

All motors are fully retracted.

Once the reference movement is complete, the system is reset and can be operated as usual.

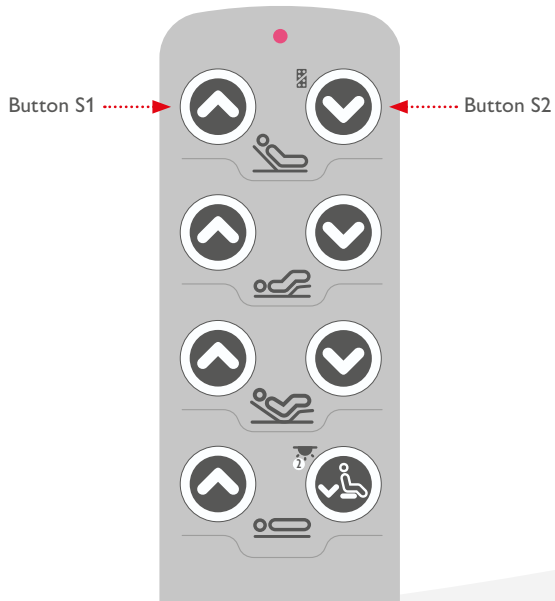

# FUNCTION ILLUSTRATION

## IMPULSE care bed with undercarriage Edition 400

Version with vertically retractable side rails with one-handed operation, split on both sides (EVGS 7.5.31)

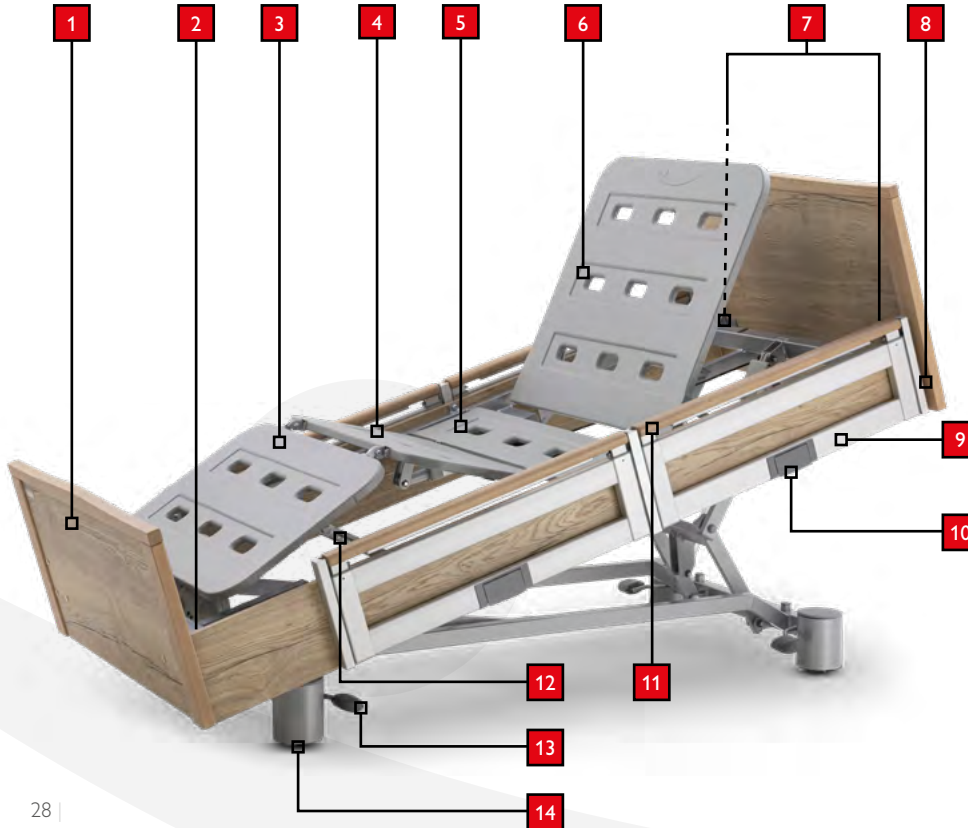

1. Footboard
2. Integrated two-stage bed extension (+10/+20 cm)
3. Adjustable lower leg rest
4. Adjustable thigh rest
5. Static seat section
6. Adjustable back rest
7. Receiving sleeve for IV drip holder and accessories (4x surrounding the bed)
8. Mechanical CPR emergency lowering of the back rest (optional)
9. Vertically retractable side rail with one-handed operation
10. Unlocking (one-handed operation) side rails
11. Telescopic side rail movement
12. Lower leg rest adjustable ratchet
13. Foot pedal with axle brake (▼) and freewheeling (▲)
14. Concealed 50 mm castors

# FUNCTION ILLUSTRATION

## IMPULSE care bed with undercarriage Edition 400 ZB

Version with vertically retractable side rails with one-handed operation, head side (EVGSK 7.5.31)

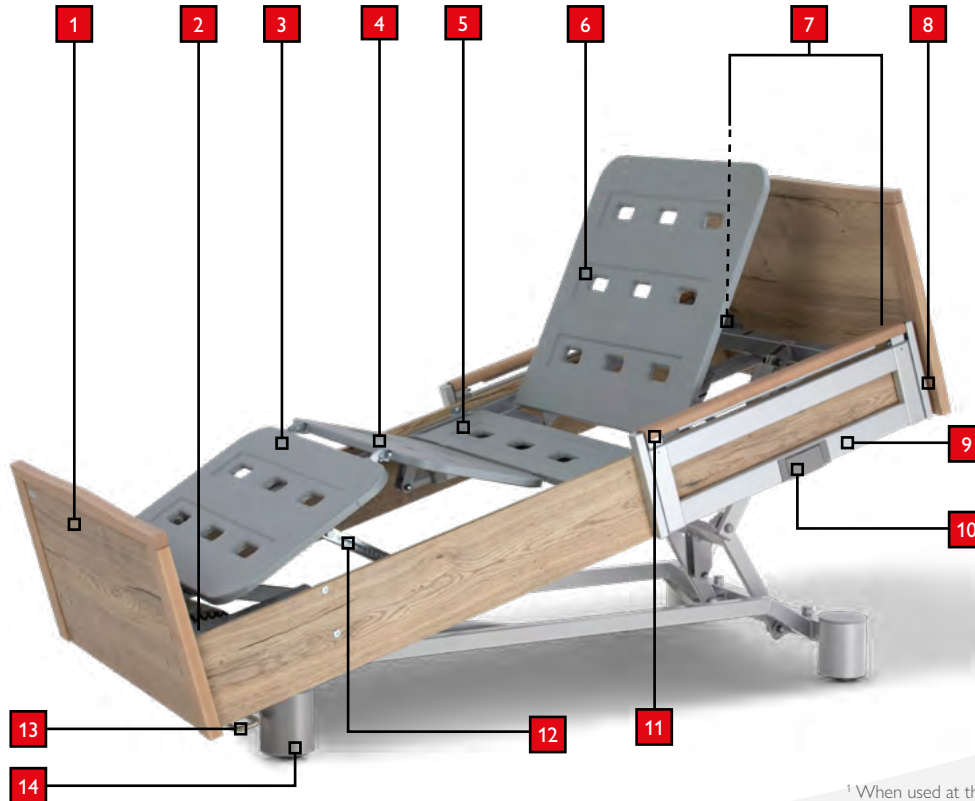

1. Footboard
2. Integrated two-stage bed extension (+10/+20 cm)
3. Adjustable lower leg rest
4. Adjustable thigh rest
5. Static seat section
6. Adjustable back rest
7. Receiving sleeve for IV drip holder and accessories (4x surrounding the bed)
8. Mechanical CPR emergency lowering of the back rest (optional)
9. Vertically retractable side rail with one-handed operation<sup>1</sup>
10. Unlocking (one-handed operation) side rails
11. Telescopic side rail movement
12. Lower leg rest adjustable ratchet
13. Brake pedal with central brake (▼) and freewheeling (▲)
14. Concealed 50 mm castors

<sup>1</sup> When used at the head side there is no protection from falling out of the bed. Only use as a mobilisation rail!

# FUNCTION ILLUSTRATION

## IMPULSE care bed with undercarriage Edition 400LR

Version with vertically retractable side rails with one-handed operation, head side (EVGSK 7.5.31)

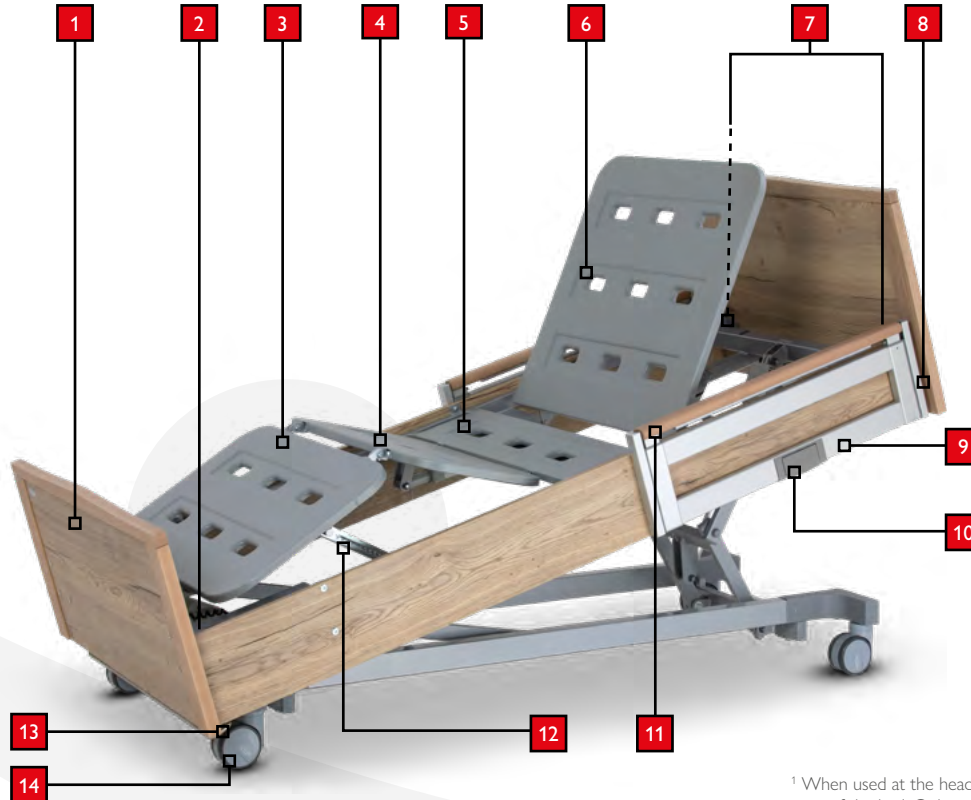

1. Footboard
2. Integrated two-stage bed extension (+10/+20 cm)
3. Adjustable lower leg rest
4. Adjustable thigh rest
5. Static seat section
6. Adjustable back rest
7. Receiving sleeve for IV drip holder and accessories (4x surrounding the bed)
8. Mechanical CPR emergency lowering of the back rest (optional)
9. Vertically retractable side rail with one-handed operation<sup>1</sup>
10. Unlocking (one-handed operation) side rails
11. Telescopic side rail movement
12. Lower leg rest adjustable ratchet
13. Brake pedal with central brake (▼), fixed direction (▲) and freewheeling (—)
14. 100mm twin castor

<sup>1</sup> When used at the head side there is no protection from falling out of the bed. Only use as a mobilisation rail!

# FUNCTION ILLUSTRATION

## IMPULSE care bed with undercarriage Edition 420

Version with folding side rails, split on both sides (GS V3.3)

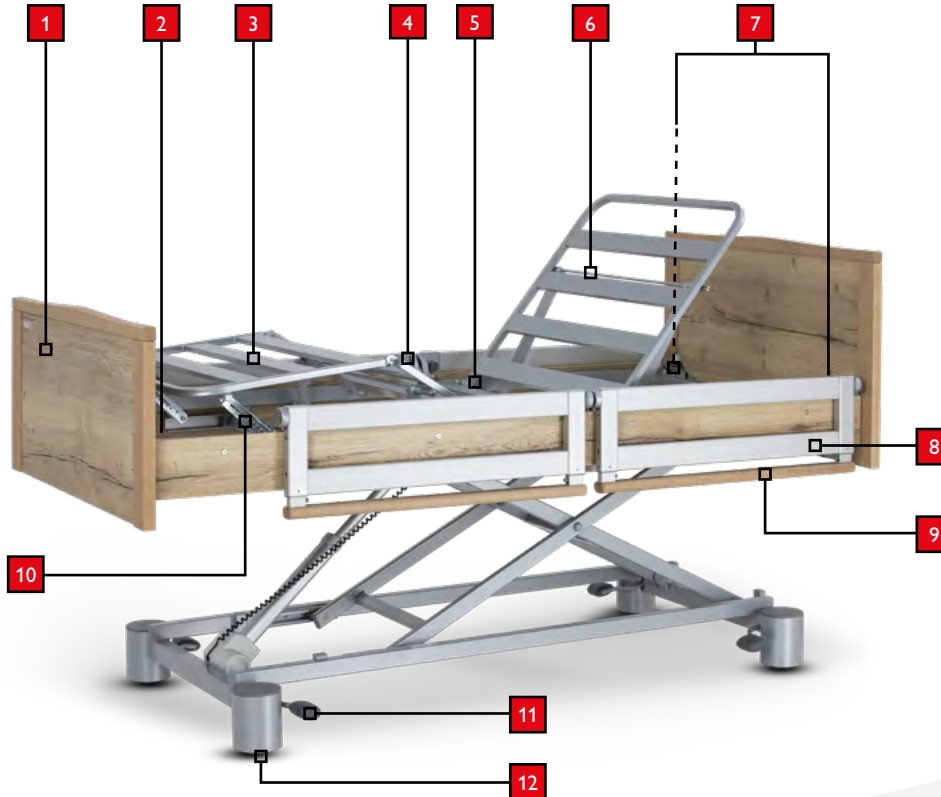

1. Footboard
2. Integrated, two-stage bed extension (+10/+20 cm) (optional)
3. Adjustable lower leg rest
4. Adjustable thigh rest
5. Static seat section
6. Adjustable back rest
7. Receiving sleeve for IV drip holder and accessories (4x surrounding the bed)
8. Folding side rails
9. Telescopic side rail extension
10. Lower leg rest adjustable ratchet
11. Foot pedal with axle brake (▼) and freewheeling (▲)
12. Concealed 50 mm castors

## FUNCTION ILLUSTRATION

### IMPULSE care bed with undercarriage Edition 420LR

Version with folding side rails, split on both sides (GS V3.3)

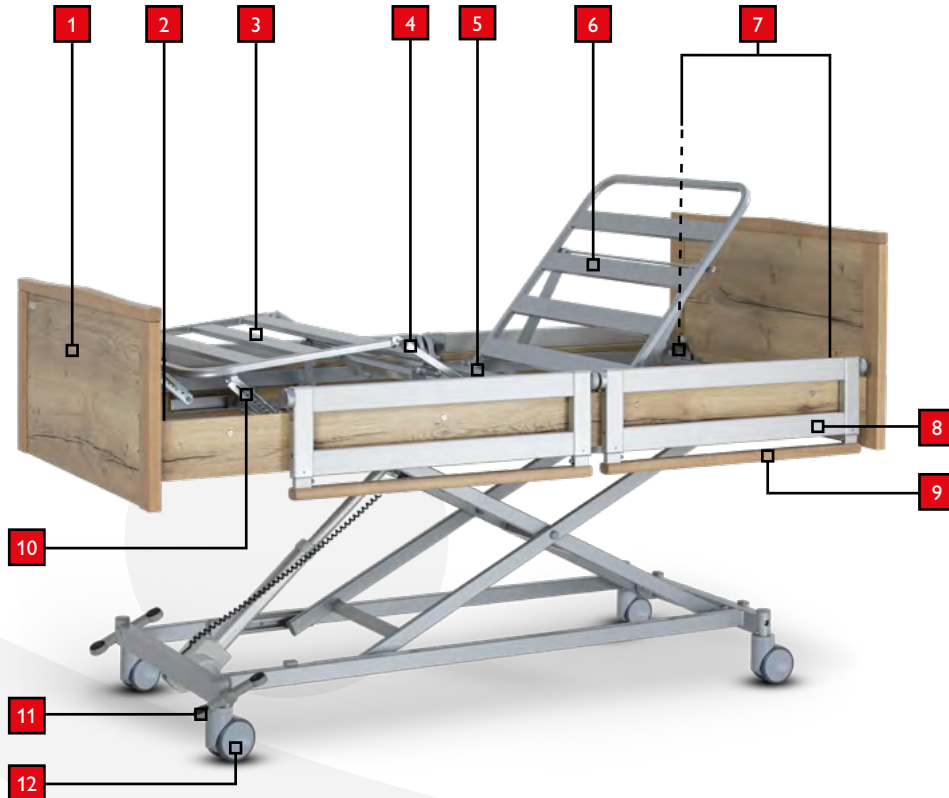

1. Footboard
2. Integrated, two-stage bed extension (+10/+20 cm) (optional)
3. Adjustable lower leg rest
4. Adjustable thigh rest
5. Static seat section
6. Adjustable back rest
7. Receiving sleeve for IV drip holder and accessories (4x surrounding the bed)
8. Folding side rails
9. Telescopic side rail movement
10. Lower leg rest adjustable ratchet
11. Foot pedal with central brake (▼), fixed direction (▲) and freewheeling (—)
12. 100mm twin castor



## FUNCTION ILLUSTRATION

### IMPULSE care bed with undercarriage Edition 500

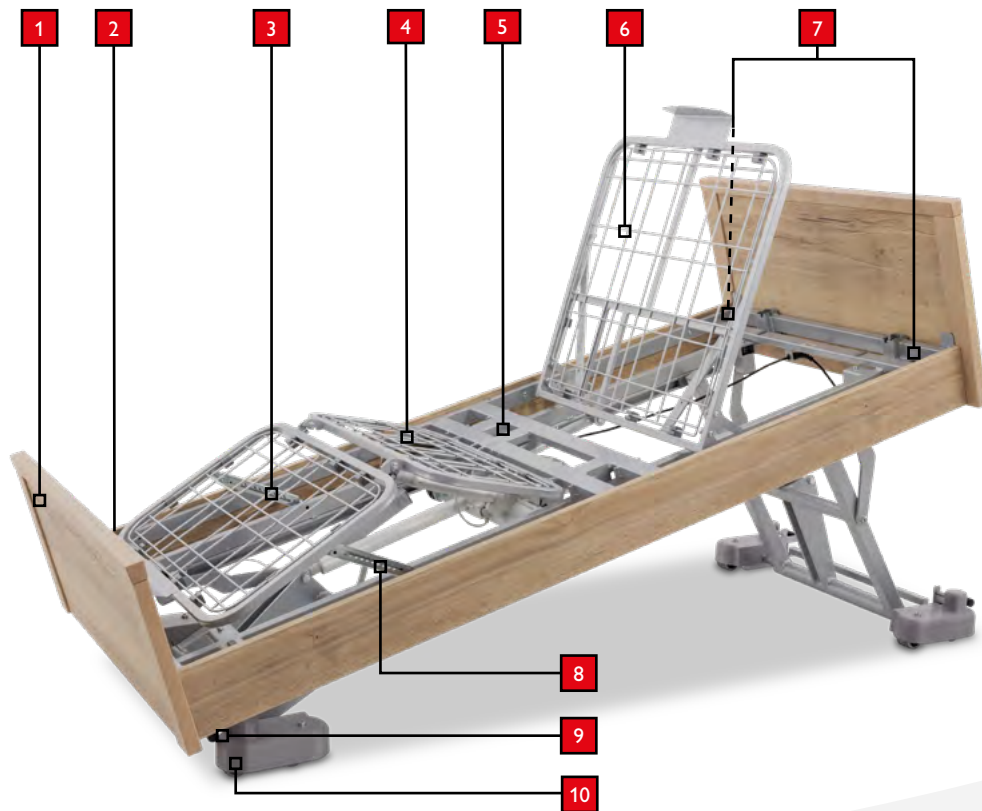

1. Footboard
2. Integrated two-stage bed extension (+10/+20 cm)
3. Adjustable lower leg rest
4. Adjustable thigh rest
5. Static seat section
6. Adjustable back rest
7. Receiving sleeve for IV drip holder and accessories (4x surrounding the bed)
8. Lower leg rest adjustable ratchet
9. Foot pedal with axle brake (▼) and freewheeling (▲)
10. Concealed 50 mm twin castor

# FUNCTION ILLUSTRATION

## IMPULSE care bed with undercarriage Edition XL

Version with folding side rails, split on both sides (GS V3)

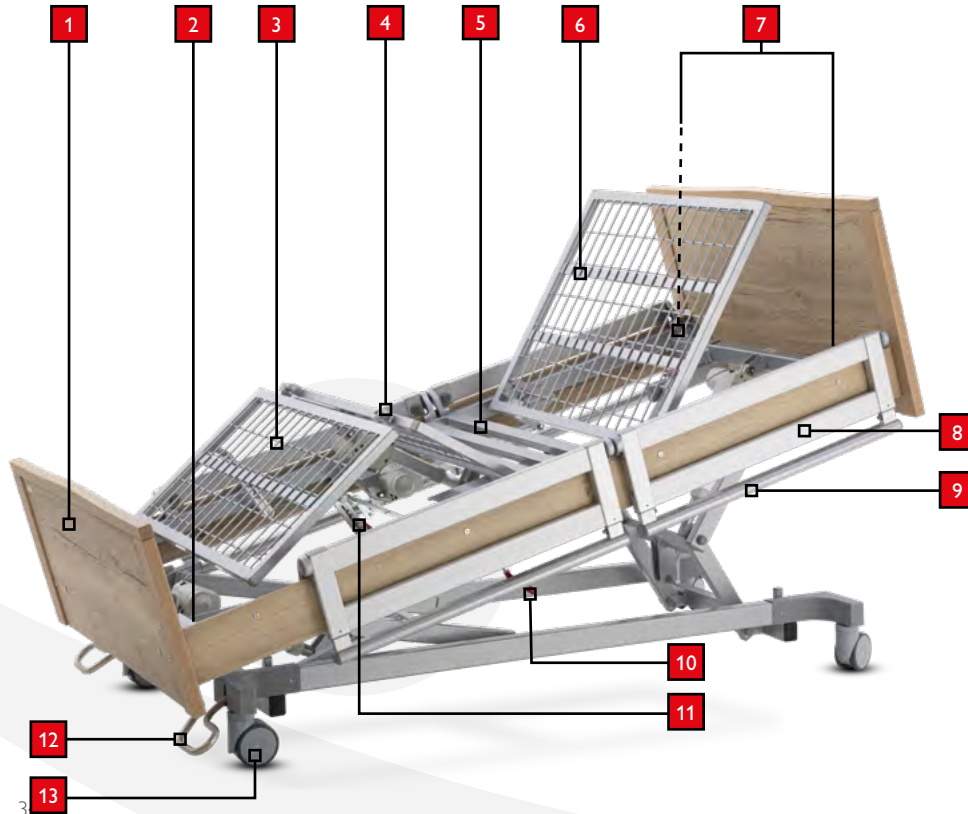

1. Footboard
2. Integrated two-stage bed extension (+10/+20 cm)
3. Adjustable lower leg rest
4. Adjustable thigh rest
5. Static seat section
6. Adjustable back rest
7. Receiving sleeve for IV drip holder and accessories (4 x surrounding the bed)
8. Folding side rails
9. Telescopic side rail extension
10. CPR emergency lowering (optional, design with GS)
11. Lower leg rest adjustable ratchet
12. Brake pedal with central brake (▼), fixed direction (▲) and freewheeling (—)
13. 100 mm twin castor

# FUNCTION ILLUSTRATION

## AURA care bed

Version with vertically retractable side rails with one-handed operation, split on both sides (EVGS 7.5.30)

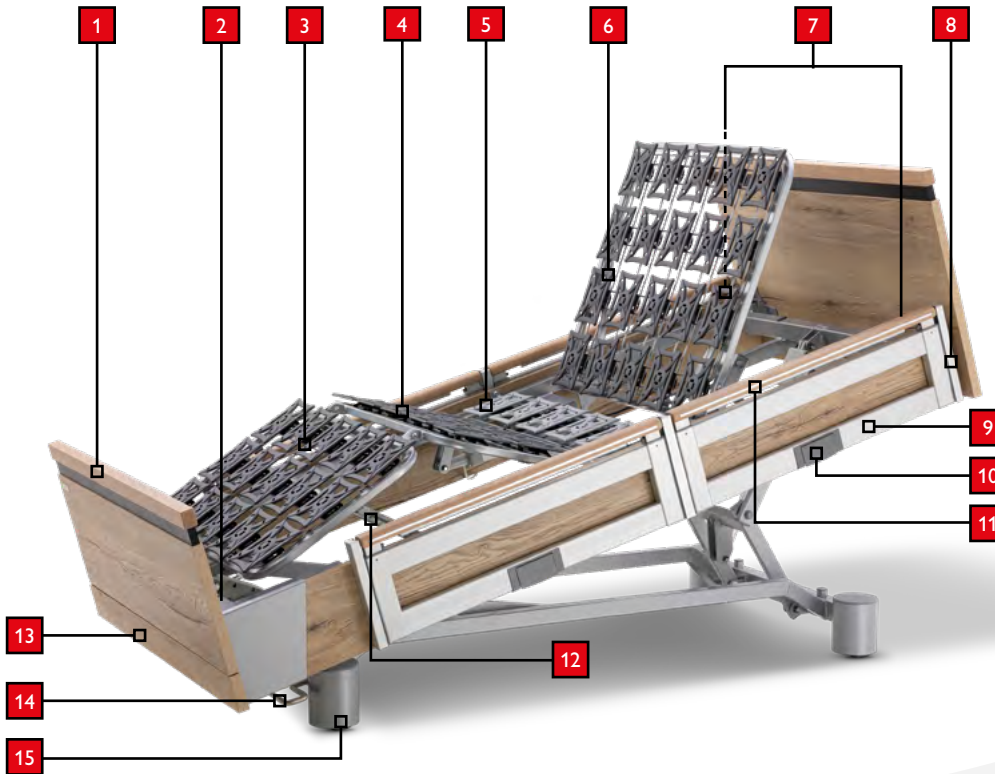

1. Footboard
2. Integrated two-stage bed extension (+10/+20 cm)
3. Adjustable lower leg rest
4. Adjustable thigh rest
5. Static seat section
6. Adjustable back rest
7. Receiving sleeve for IV drip holder (4x surrounding the bed)
8. Mechanical CPR emergency lowering of the back rest (optional)
9. Vertically retractable side rail with one-handed operation
10. Unlocking (one-handed operation) side rails
11. Telescopic side rail movement
12. Lower leg rest adjustable ratchet
13. Pull-out bed linen holder (optional)
14. Brake pedal with central brake (▼) and freewheeling (▲)
15. Concealed 50 mm castors

# FUNCTION ILLUSTRATION

## AURALR care bed

Version with vertically retractable side rails with one-handed operation (EVGS 7.5.30)

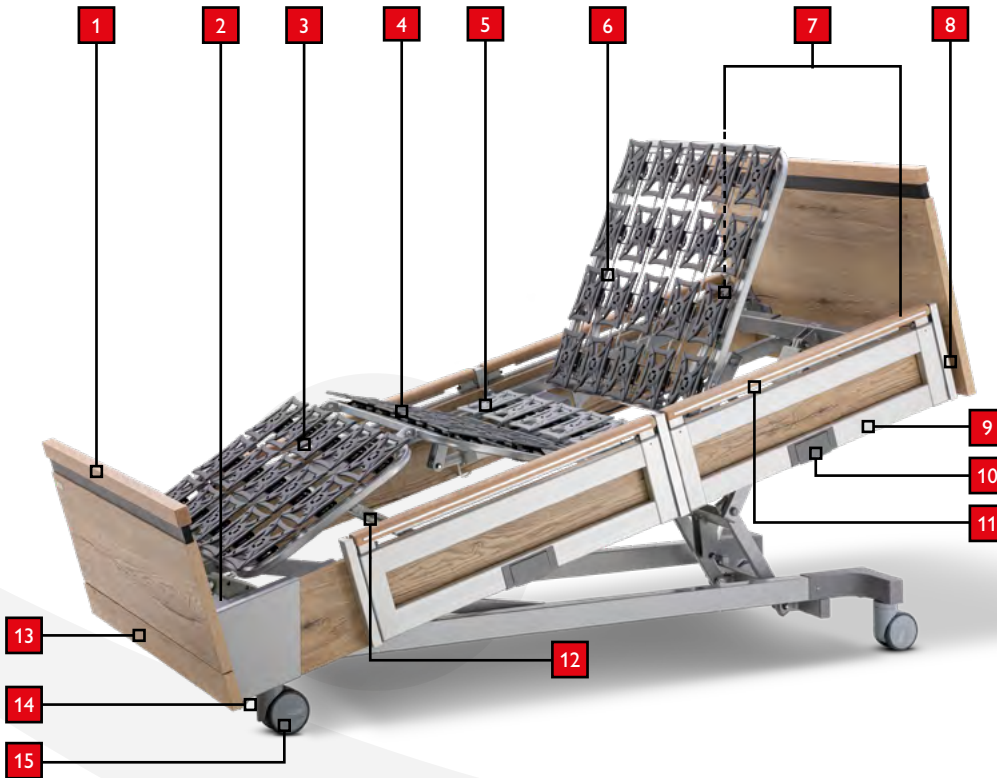

1. Footboard
2. Integrated two-stage bed extension (+10/+20 cm)
3. Adjustable lower leg rest
4. Adjustable thigh rest
5. Static seat section
6. Adjustable back rest
7. Receiving sleeve for IV drip holder and accessories (4x surrounding the bed)
8. Mechanical CPR emergency lowering of the back rest (optional)
9. Vertically retractable side rail with one-handed operation
10. Unlocking (one-handed operation) side rails
11. Telescopic side rail movement
12. Lower leg rest adjustable ratchet
13. Pull-out bed linen holder (optional)
14. Brake pedal with central brake (▼), fixed direction (▲) and freewheeling (—)
15. 100 mm twin castor



# DESCRIPTION OF FUNCTION

Depending on the design and type of care bed, it can be moved into various positions by adjusting the back rest, the thigh rest, the lower leg rest and the lift adjustment:

## Back rest

Use the relevant buttons on the hand controller to adjust the back rest.



(Back rest operating buttons)

The back rest has length compensation of 120mm<sup>1</sup> in its movement sequence in relation to the headboard of the bed (Edition 420/420 LR undercarriages **optionally** available with 100mm back rest mattress compensation).

This function (mattress compensation) allows the residents to sit in a comfortable position while avoiding compression of the buttock area and the stomach and upper body area.



**Caution! The back rest is designed for the mechanical load applied when raising a reclining person with a maximum resident weight according to the specification on the rating plate. Sitting on the back rest is not the intended specific function and may result in damage and injury.**

## Mechanical back rest release/CPR

(optional)

### Design with VGS

Handle at head end on a level with the side



When operating the mechanical release, hold the back rest in the current position and, if possible, relieve some of the load. Pull the release to disengage the back rest and lower it manually into the end position.

### Design with GS/design without side rails

Handle in the middle of the bed below the side panel.



When operating the mechanical release, hold the back rest in the current position and, if possible, relieve some of the load. Pull the release lever towards the back rest to disengage the back rest and lower it manually into the end position.

Press the S1 button on the hand controller again to reactivate electrical back rest adjustment.

<sup>1</sup> Undercarriage Editions 500/400/400ZB/400LR/XL as well as AURA and AURA LR



---

Caution! Before pressing the lever, it must be ensured that there are no objects or parts of the body beneath the back rest. Manually relieve the weight on the back rest during adjustment to prevent it from dropping in an uncontrolled manner.

---



---

Caution! Please consider resident safety when adjusting the auto contour! Ensure that that no objects or parts of the body are located in the area of the lifting mechanism.

---

## Adjustable thigh/lower leg rest

Use the corresponding buttons on the hand controller to adjust the thigh rest.



(Thigh rest operating buttons)

Care staff can move the lower leg rest into the extended leg elevation position using the adjustable notched bracket.

## Height adjustment

Use the relevant buttons on the hand controller to adjust the height.



(Height adjustment operating buttons)

## Auto contour

Use the corresponding buttons on the hand controller to adjust the auto contour.



(Auto contour operating buttons)

Using the button function adjusts both the back rest and thigh rest.<sup>1</sup>

This function must only be used with mobile residents without any physical problems.



---

Caution! Please consider resident safety when adjusting the height! Ensure that that no objects or parts of the body are located in the area of the lifting mechanism.

---

<sup>1</sup> Not for HB-400 6-button hand controller

## Transfer position

The transfer position makes it easier to get in and out of bed with the buttock area of the bed at sitting height. Hold the operating button down until the position is reached.



(Transfer position operating button)

## Low position/fall prevention

Use the corresponding buttons on the hand controller to adjust the bed to the low position.



(Low position operating button)

Press the button to lower the bed from the transfer position to the low position.

The Edition 420/420 LR version of the IMPULSE care bed does not have a separate button for the low position. In this case, the system automatically stops in the transfer position when lowering. Another press of the operating button is required in the transfer position to move the bed to the low position.



---

**Caution!** Before pressing the button, it must be ensured that the telescopic side rail extension on the dropped-down split side rail (GS) is pushed in (P. 48, Fig. 1). Ensure that that no objects or parts of the body are located under the bed.

---

## Trendelenburg position

(Not with the IMPULSE care bed with undercarriage Edition XL<sup>1</sup>/ Edition 420 or Edition 420 LR)

The bed is moved to the Trendelenburg position using the relevant buttons on the hand controller:



(Trendelenburg position operating button)

The Trendelenburg position is locked for safety reasons when the bed is in resident setting.



---

**Caution!** Please observe the instructions for the locking function P. 42

---



---

**Caution!** The Trendelenburg function cannot be implemented if a power supply failure occurs in combination with an empty battery or if the lifting motors fail. In this case, the resident must be relocated to another bed as required.

---





Caution! The Trendelenburg position must only be used if prescribed by a doctor. Improper use can result in lasting injury to residents.

---

## Reverse Trendelenburg position

(Not with the IMPULSE care bed with undercarriage Edition XL<sup>1</sup>/ Edition 420 or Edition 420LR)

The bed is moved to the reverse Trendelenburg position (feet lowered) using the relevant buttons on the hand controller:



(Reverse Trendelenburg operating button)

The inclination of the sleeping surface can be found in the table on [P. 14](#) and [P. 16 Technical Data](#).



Caution! Please consider resident safety when adjusting the bed inclination! Ensure that that no objects or parts of the body are located in the area of the lifting mechanism.

---

## Automatic chair position

(Not with IMPULSE care bed with undercarriage Edition 420/420LR)

Use the corresponding buttons on the hand controller to adjust the automatic chair position.



(Automatic chair position operating buttons)

If the button function is pressed, the bed is quickly moved into a cardiac chair position.

This function must only be used with mobile residents without any physical problems.



Caution! Please consider resident safety when adjusting the bed to the automatic chair position. Ensure that that no objects or parts of the body are located in the area of the lifting mechanism.

---



Caution! When activating the reverse Trendelenburg position or automatic chair position in conjunction with a pull-out bed extension, ensure that there are no objects or parts of the body below the foot end of the bed.

---

<sup>1</sup> In the standard model. Available as an option.

## Hand controller locking function

The electrical unit combines state-of-the-art technology and single-fault safety.

The locking function is an additional safety precaution.

### Operating the JCH-35A6 12-button hand controller locking function

Activating the locking function requires a magnetic chip, and is confirmed by pressing the respective function key *☞ P. 23-24 Hand controller symbols*.

The Trendelenburg/ reverse Trendelenburg position is automatically locked after 90 seconds of inactivity for safety reasons, and can be temporarily released using the magnetic chip. *☞ P. 23 Hand controller symbols*

Beds with the relevant scope of functionality can then be moved into the Trendelenburg position using the S9 and S10 buttons on the hand controller. The inclination angle of the sleeping surface can be found in the table on *☞ P. 14 - P. 16 Technical Data*.

The Trendelenburg or reverse Trendelenburg position is automatically locked again after 90 seconds.



## Operating the HB-400 hand controller locking function

The supplied magnetic chip must be placed in the area marked in red of the hand controller to activate the locking function (*☞ P. 25, HB-400 hand controller locking functions*). The respective lock button (for secondary assignment symbols, see table *☞ P. 25, HB-400 hand controller locking functions*) must be pressed at the same time. A red LED in the centre of the row of buttons acknowledges that the function lock has been activated.



The locked functions are released in the same way. By placing the magnetic chip and simultaneously pressing the button with the lock symbol, the function is released again and the respective LED goes out. (*☞ P. 25, HB-400 hand controller locking functions*)

The locking function of the Trendelenburg position is also activated using the supplied magnetic chip (*☞ P. 25, HB-400 hand controller locking functions*). The locked function is released in the same way.

## Braking and moving

### IMPULSE care bed with undercarriage Edition 400/420 and 500

The IMPULSE care bed with undercarriage Edition 400/420 and 500 (mobile at any positioning height) has one central castor brake for each axle, which is operated mechanically using a foot pedal that is accessible on both sides.



Foot pedal Edition 400/420

The IMPULSE care bed with undercarriage Edition 400/420 and 500 offers two different adjustment options:

1. Castors braked (foot pedal down)
2. Castors enabled for 360° movement (foot pedal up)



Foot pedal Edition 500

### IMPULSE care bed with undercarriage Edition 400LR

### IMPULSE care bed with undercarriage Edition XL

Edition 400LR and Edition XL of the IMPULSE care bed with undercarriage has one central castor brake, which is operated mechanically using a central brake pedal. The brake pedal is located in the central foot area of the undercarriage.



The brake system offers the following positions:

1. Central braking of the castors (brake pedal in bottom position)
2. Four castors released for 360° movement (brake pedal in the middle)
3. Directional locking of one castor (brake pedal in upper position)

## IMPULSE care bed with undercarriage Edition 420LR

The IMPULSE care bed with undercarriage Edition 420LR has one central castor brake, which is operated mechanically using a central foot pedal. The foot pedals are located above the castors at the foot of the bed and are accessible from both sides.



The brake system offers the following positions:

1. Central braking of the castors  
(external foot pedal in bottom position)
2. Four castors released for 360° movement  
(horizontal foot pedal)
3. Directional locking of one castor  
(external foot pedal in upper position)



---

Caution! The IMPULSE care bed with undercarriage Edition 400/400LR/420/420LR/500 and XL can be moved with the sleeping surface at any height. However, this should only be done in exceptional cases and under the supervision of care staff. Once the bed has been moved to its final position, check that the castor brakes have been applied to ensure the bed is in braked mode. The resident's safety is the top priority!

---

## IMPULSE care bed with undercarriage Edition 400ZB, AURA care bed

The IMPULSE care bed with undercarriage Edition 400ZB and the AURA care bed have a central castor brake, which is operated mechanically using a brake pedal at the foot of the bed. The brake pedal is as wide as the entire undercarriage, making it accessible from both sides.



The brake system offers the following positions:

1. Central braking of the castors  
(brake pedal in bottom position)
2. Four castors released for 360° movement  
(brake pedal in the middle)



---

Caution! The IMPULSE care bed with undercarriage Edition 400ZB and the AURA care bed can be moved with the sleeping surface at any height. However, this should only be done in exceptional cases and under the supervision of care staff. Once the bed has been moved to its final position, check that the castor brakes have been applied to ensure the bed is in braked mode. The resident's safety is the top priority!

---

## AURA LR care bed

The AURA LR model with optional castor sizes of 100 mm or 125 mm features a central castor brake, which is operated mechanically using a central foot brake pedal. The brake pedal is located in the central foot area of the undercarriage.



The brake system of the AURALR offers the following positions:

1. Central braking of the castors  
(brake pedal in bottom position)
2. Four castors released for 360° movement  
(brake pedal in the middle)
3. Directional locking of one castor  
(brake pedal in upper position)



---

**Caution!** The AURA LR care bed can be moved with the sleeping surface at any height setting. However, this should only be done in exceptional cases and under the supervision of care staff. Once the bed has been moved to its final position, check that the castor brakes have been applied to ensure the bed is in braked mode. The resident's safety is the top priority!

---

## Adjust DS side rails

### Full-length side rails

In the starting position, the side rails are located on top of one another next to the sleeping surface frame.

#### 1. Raising function:

Lift the upper side rail bar by the side rail groove (B) until you hear both safety buttons (A) lock into place.



Caution! Check that the side rail is locked in place by rattling it several times.

#### 2. Lowering function:

Slightly lift the upper side rail bar by the side rail groove (B), while at the same time pushing in the safety button (A). Slowly lower the side rail to the lowest position. Repeat the process at the other end of the bed.



Caution! When lowering and raising the side rails, please be extremely careful not to trap fingers, hands or any other parts of the body between the side rails and the sleeping surface frame.

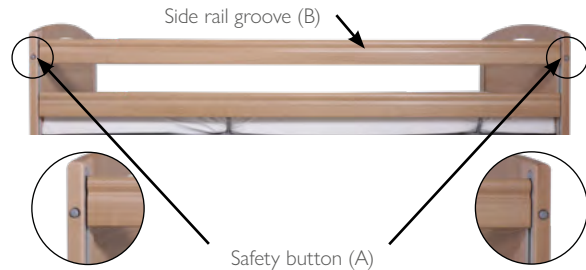

Caution! For disorientated or undernourished residents, we strongly recommend using upholstered side rail covers to prevent limbs from becoming trapped in the gaps between the side rail bars, which could lead to injury.

## DS side rail dimensions

When using with ABS, metal grid and wooden slats sleeping surface

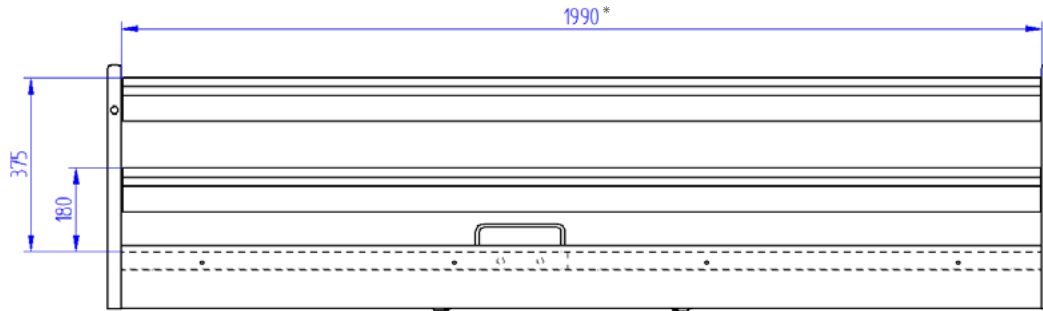

When using the comfort sleeping surface

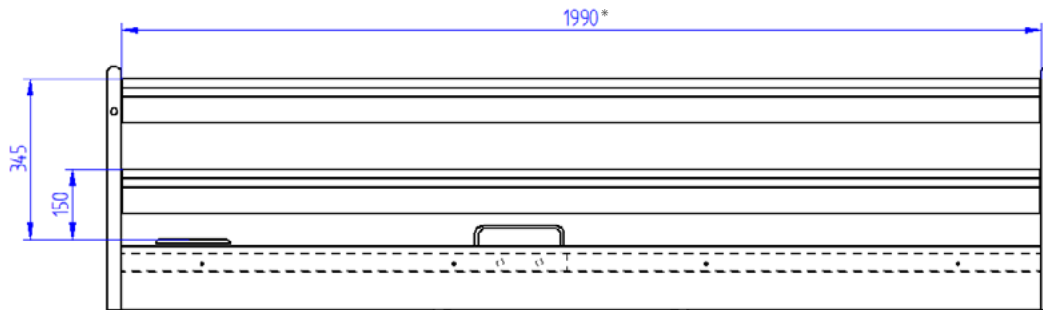

\*Dimensions in mm for standard sleeping surface (90x200cm); dimensions for other lengths will differ.

## Adjustment of side rails GS<sup>1</sup>

### Split side rails

In standby position, the side rails are located next to the sleeping surface and thus prevent the mattress from slipping. (Fig. 1)

1. The side rails are raised by tilting them upwards. In this middle position, they prevent the patient falling out of bed. When raised at the head end, they also provide a stable standing and mobilisation rail for the resident. (Fig. 2)
2. The upright side rail is released by means of two spring catches in the side rail bars below the height adjustment handrail and positioned at its maximum height. Perform telescopic adjustments upwards and downwards using both hands simultaneously to prevent jamming (Fig. 3).

**Do not force the movement!**

3. To lower the telescoping side rail height extension, proceed the same way as to raise it.
4. To fold the side rails back into their standby position, press the indicated release latches on the lower side rail bar inwards simultaneously and initiate the tilting motion. (Fig. 4)



Caution! When raising the side rails and side rail height extensions, check that the latches engage securely. Always use both hands to move this element!



Caution! Activate the low position for the low IMPULSE and AURA care beds only once the telescopic side rail extension on the folded split side rail (GS) has been pushed in (Fig. 1).



Fig. 1

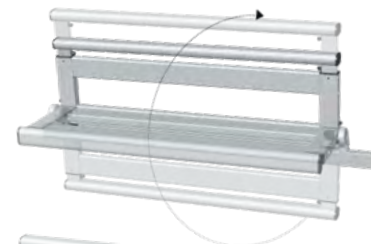

Fig. 2



Fig. 3

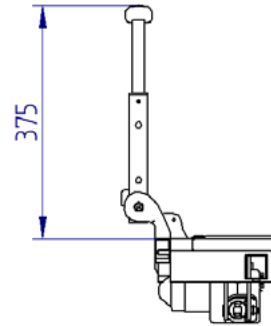
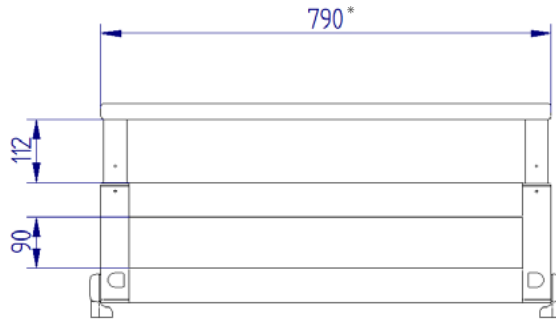

Fig. 4



## GS side rail dimensions

When using with ABS, metal grid and wooden slats sleeping surface



When using the comfort sleeping surface

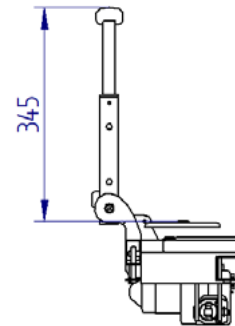
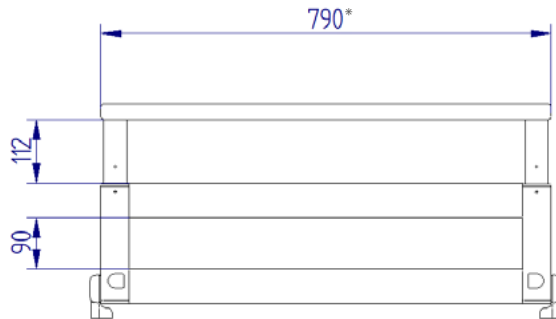

\* Dimensions in mm for standard side rails (GS V3.3), dimensions for other designs will differ.

## Adjustment of side rails VGS<sup>1</sup>

### Vertically lowering split side rails

In standby position, the side rails are located next to the sleeping surface and thus prevent the mattress from slipping.

1. To raise the side rails, pull them upwards with both hands until they engage with an audible click. In this middle position, they prevent the patient falling out of bed. When raised at the head end, they also provide a stable standing and mobilisation rail for the resident. (Fig. A, 1.)
2. The side rail extension can be released using the two spring catches below the handrail for telescopic movement and adjusted to maximum height. Pull the rail upwards using both hands at the same time (Fig. B, 1./2). Take care not to tilt and jam the element. Follow these actions in reverse to lower the rail. **Do not force the movement!**
3. To lower the side rails, push the two release slides inwards with both hands (Fig. A, 2.) and lower the side rails carefully into the standby position.



Caution! When raising the side rails and side rail height extensions, check that the latches engage securely. Always use both hands to move this element!



Fig. A

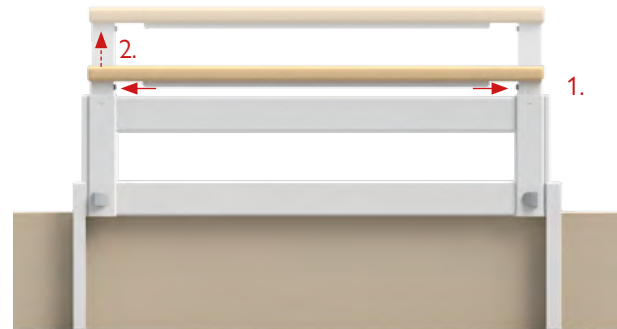

Fig. B

## Adjustment of side rails EVGS<sup>1</sup>

### Vertically lowering split side rails with one-handed operation

In standby position, the side rails are located next to the sleeping surface and thus prevent the mattress from slipping.

1. To raise the side rails, pull them upwards with both hands until they engage with an audible click. In this middle position, they prevent the patient falling out of bed. When raised at the head end, they also provide a stable standing and mobilisation rail for the resident. (Fig. A, 1.)
2. The side rail extension can be released using the two spring catches below the handrail for telescopic movement and adjusted to maximum height. Pull the rail upwards using both hands simultaneously (Fig. B, 1./2). Take care not to tilt and jam the element. Follow these actions in reverse to lower the rail. **Do not force the movement!**
3. To lower the side rails, pull the release handle forward with one hand (Fig. A, 2.) and carefully lower the side rails into the standby position.



**Caution!** When raising the side rails and side rail height extensions, ensure and check that the latches engage securely.



Fig. A

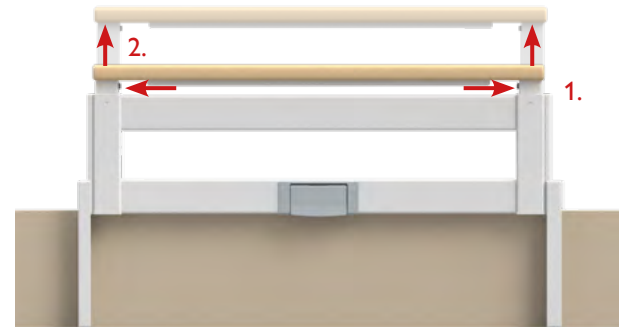
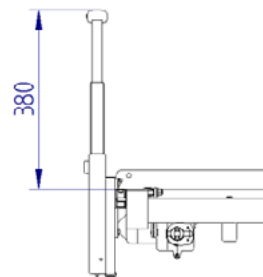
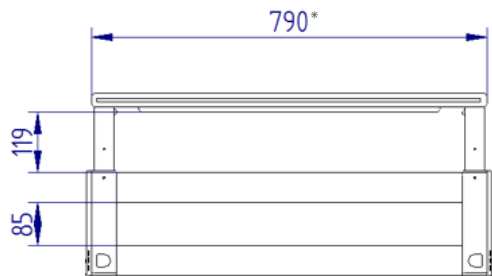

Fig. B

## VGS side rail dimensions

When using with ABS, metal grid and wooden slats sleeping surface



When using the comfort sleeping surface

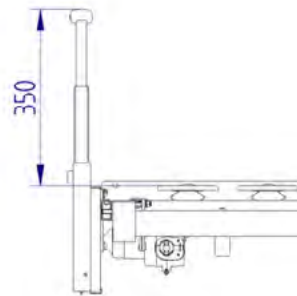
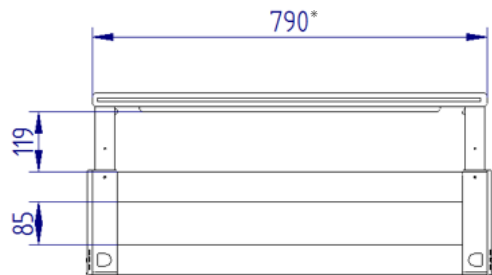

\* Dimensions in mm for standard side rails (VGS 05:30), dimensions for other designs will differ.

## Different lengths of the GS and VGS side rails

### Folding split side rails V2

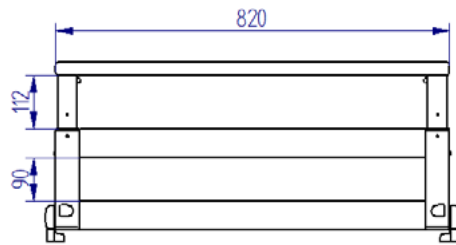

Head side

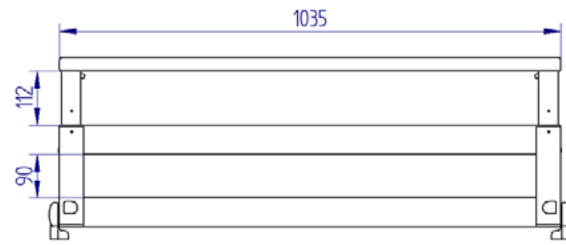

Foot end

### Vertically lowering split side rails V2

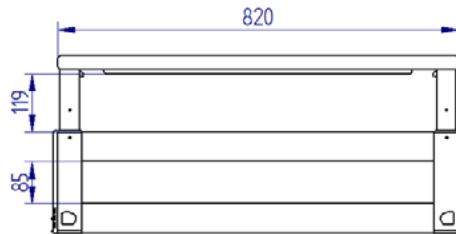

Head side

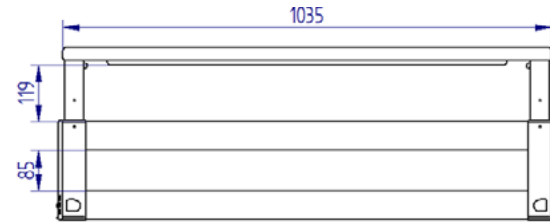

Foot end

## Integrated bed extension

Beds equipped at the factory with an integrated bed extension can be extended by up to 20 cm without tools. For this to be possible, the side rail bars must be replaced with full-length side rails.

This function is activated in three stages and without tools using the two locking bolts at the bottom foot end of the sleeping surface:

1. For the IMPULSE care bed with an undercarriage Edition 400/400LR and for the AURA/AURA LR care bed, both locking bolts (Fig. A) must be pulled upwards and then rotated about a quarter of a turn to the right to the stop point. In the case of the IMPULSE care bed with undercarriage Edition 420/420 LR, the locking bolts are positioned laterally and point to the middle of the bed (P. 55 Fig. B). The operation is similar to the undercarriage editions described above. The bed extension is now unlocked.
2. Reach below the foot board and carefully pull out the bed extension by approx. 10 cm or 20 cm.
3. The locking bolts are turned back to the starting position and the bed extension is then pushed back gently until the mechanism clicks into place.

IMPULSE care bed with undercarriage Edition 400/400ZB/400LR and AURA/AURA LR care bed



IMPULSE care bed with undercarriage Edition 420/420LR and Edition 500

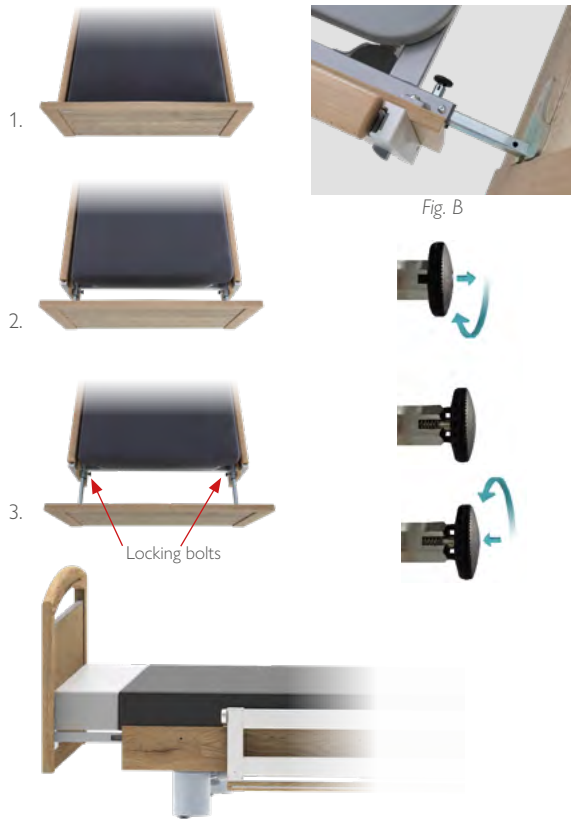

---

Caution! A mattress insert (accessory) must be used with 20 cm extensions. To use a mattress insert, first pull the bed extension out as far as it will go. Once the insert has been positioned, continue as described in point 3.

---



---

Caution! The sleeping surface extension must only be activated by authorised specialist staff.

---



---

Caution! When activating the reverse Trendelenburg position or automatic chair position in conjunction with a pull-out bed extension, ensure that there are no objects or parts of the body below the foot end of the bed.

---



---

Caution! For reasons of safety, it is essential to replace existing safety elements and attachments if the sleeping surface extension is activated on beds with full-length side rails!

---

# MAINTENANCE

The manufacturer is only liable for the safety and reliability of the product if it is serviced regularly and used in accordance with the safety instructions. If any significant defects are found during maintenance work which mean that safe operation of the product cannot be guaranteed, the product must be taken out of service. Maintenance work must be carried out at least once a year.



Any defects that impair the function and safety of the care bed must be resolved before the bed is used again and must be reported to the responsible person.

Only original replacement parts from Malsch GmbH are permitted to be used.



Service and maintenance tasks must not be conducted when the bed is occupied. The residents or the care staff must not conduct maintenance tasks.

## Procedure

### 1. Visual inspection

Check the welded structures for cracked weld seams and for plastic deformation and wear. The welded structures include the undercarriage and the sleeping surface with the moving interior components. Also check that all screw joints are firmly connected.

### 2. Level of protection and functionality check of the side rails

During the functionality check, determine whether the side rails can be easily locked in place and ensure that no impermissible wear or deformation is visible.

The spacing requirements stipulated in IEC 60601-2-52:2009/AMD:2015 are used to check the level of protection. This is shown schematically by the following illustrations and the table:

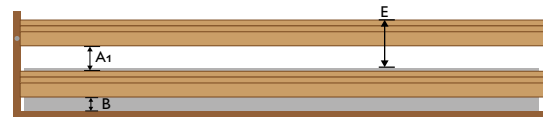

Fig. 1 (dimensions of a continuous side rail)

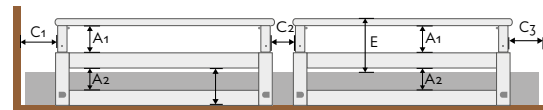

Fig. 2 (dimensions of a split side rail)



Check whether the required spacings are also complied with under load. Dimensions A and C must be checked with a testing tool in accordance with IEC 60601-2-52:2009/AMD:2015. The test force for dimension A is 250 N.

Dimensions		Requirement
A1	Completely enclosed opening inside the side rail	< 120 mm
A2	Completely enclosed opening which is produced by the arrangement of the side rail, its supports and the sleeping surface in relation to each other	< 120 mm
B	Distance between sleeping surface and lowest point of the side rail on the outside of the rail support	< 60 mm
C1	Opening between headboard and neighbouring side rail	< 60 mm
C2	Opening between segmented or split side rails	< 60 mm or > 318 mm
C3	Opening between side rail and foot section	< 60 mm or > 318 mm
D	Area between side rail and mattress	As per the testing conditions in the standard
E	Height of top edge of side rail in relation to the top edge of the mattress, resulting in a thickness of the mattress that is used (without compression, as specified by the manufacturer) with side rail version VGS, with side rail version GS and with side rail version DS	< 220 mm  12- 16 cm* 12- 15 cm* 12- 15 cm*

\* only applies to ABS and metal mesh sleeping surface. When using the comfort sleeping surface, a maximum mattress height of 12 cm is permissible.

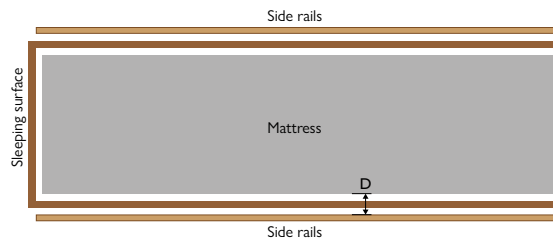

### 3. Function test of the brakes

Depending on the variant, the function of the brakes must be tested in every position. With electrical brake systems, check whether the brakes fully retract and extend.

### 4. Function test of the lifting motors

Move all lifting motors to their end position and back again. When doing so, please observe the following points:

- Any unusual noises generated
- Synchronism of the lifting motors
- Smooth operation of the lifting motors
- Correct path of the lifting motors
- Automatic switch-off in the end position

The travel path of the lifting motors may vary depending on the model variant. If in doubt, please contact our customer service.

## 5. Visual inspection of mains connection cable

Check the following points on the mains connection cable:

- Visually inspect and check the function of the strain relief and kink protection
- Visual inspection of the insulation parts
- Visual inspection of the connection cables (damage, crushing)
- Visual inspection of the mains connection plug
- Visual inspection of the cable hooks

## 6. Visual inspection of wiring

Check the following points:

- Damage to the cables
- Correct cable routing
- Proper seating of plug connections and pull-out protection

## 7. Visual inspection of housing

The housings must be checked for external damage and intact seals.

## 9. Measurements in line with DIN EN 62353

The electrical testing of the care bed must be carried out as specified in DIN EN 62353. The leakage current is measured with the aid of the equivalent leakage current test. The limit is  $\leq 500 \mu\text{A}$ .

## 10. Visual inspection of grab handle for lifting pole

Check that the plastic components and straps show no signs of damage. The grab handles must be replaced every 5 years.

# MAINTENANCE INTERVALS

## Annually

---

- Inspection and maintenance

## As required

---

- Lubrication of mechanical components
- Replacement of worn components if a defect occurs.

## DELIVERY AND ASSEMBLY

Malsch GmbH care beds are generally delivered fully assembled, or they are assembled on site by company technicians or contractual partners.

Check the delivered bed against documentation for completeness and conformity.

Any defects or damage must be pointed out to the freight company immediately and noted on the delivery document.

Signing of the delivery documents by both parties is obligatory before commissioning.

If necessary, e.g. for maintenance, simple assembly procedures can also be performed by professional authorised persons.

### Start-up

---

Before start-up it must be ensured that the bed and all components and accessories are present and intact.

Any accessories must be fitted in accordance with the instruction manual.

It must be ensured that the power supply cable and the mains plug are undamaged, and the power supply corresponds with the information on the rating plate. The plug diagram must correspond with the national standard.

The bed must be connected to the mains power supply before starting up.

All electrical functions of the bed (back rest adjustment, thigh rest adjustment, auto-contour adjustment, height adjustment up/down, Trendelenburg/reverse Trendelenburg position) must be tested beforehand. All motors and control keys must be checked for correct functionality.

The mechanical system (CPR unlocking, mechanical lower leg rest, side rail mechanism, castor braking function) must be tested.



After maintenance and servicing work has been completed, the functionality of the electrical systems must be checked.

---



The manufacturer offers technician training for maintenance and servicing work on their care beds. A certificate obtained as part of this training authorises the holder to carry out technical work independently on the beds.

---

# DISPOSAL INSTRUCTIONS

The service life of the care bed is specified as 10 years if used appropriately.

## Disposal instructions

---

- The operator must ensure that none of the components being disposed of are infectious/contaminated.
- If the bed is scrapped, the wood, plastic and metal parts used in its construction must be separated and disposed of properly.
- If you have any questions, contact your local authority, waste-disposal company or our customer service.

## Electrical component disposal

---

- This bed is electrically adjustable and classified as a commercially used electrical device according to WEEE Directive 2012/19/EU (implemented in Germany in the electrical equipment act).
- The electrical components used are free from banned harmful substances in line with the RoHS-II Directive 2011/65/EU.
- Replaced electrical components (drives, control units, hand controllers etc.) of these beds must be treated as electronic waste in line with the WEEE Directive and disposed of properly.

## Battery disposal

---

- Any individual removed batteries that can no longer be used must be disposed of properly as defined by Directive 2006/66/EC (implemented in Germany in the battery legislation) and must not be discarded with domestic waste.
- For information on this matter, contact your local waste-disposal company or our Service department.

In other countries outside Germany/the EU, the relevant, applicable national requirements must be observed.

## ACCESSORIES (OPTIONAL)

### Lifting pole

The lifting pole can be inserted to the left and right of the head side in the designated mounting sockets on the sleeping surface frame. Please ensure that the bolt is properly seated in the notch provided on the receiving bracket.

The safe working load is 75 kg.



### IV drip holder

The IV drip holder can be inserted in the sockets provided on the sleeping surface frame to the left or right of the head/foot end.

The IV drip holder is only intended for attaching IV drips and not for hanging up other accessories or similar objects.

The maximum load is 8 kg (2 kg per hook).



### Bedside light

The bedside light is attached to the mount provided on the sleeping surface frame in the same way as the lifting pole.



---

Caution! For safety reasons, the bedside light must only be used with the care bed manufacturer's original adapter and must only be fitted by authorised specialist staff.

---



---

Follow the safety instructions in the bedside light instruction manual.

---

## Hand control holder

The additional, optional hand control holder is used to position the hand controller within reach of the resident.



Caution! The hand control holder is flexible and must not be used as a standing aid or as a grab handle.

## Integrated bed linen holder

The integrated bed linen holder can be extended by pulling at the base of the footboard. This hygienic shelf directly on the bed simplifies changing the bed linen.



# TROUBLESHOOTING

Malfunction	Possible cause	Possible solution
Drives cannot be operated using the hand controller	Mains cable is not plugged in	Plug in the mains cable
	No power to socket	Check socket
	Cable plug connection not firmly connected	Check plug connections on the motor and hand controller
	Hand controller or drive is faulty	Inform the operator, specialised dealer or our customer service
	Locking of functions on the hand controller	Enabling the functions on the hand controller (☞ P. 22)
	Drives not initialised or error saved	After resolving the error / professional repair: Clear errors and initialise drives (☞ P. 27).
	Function locked on the hand controller	<i>Unlock hand controller (see P. 42 Locking functions)</i>
Motorised adjustment system not working properly	Obstruction in the adjustment area	Check moving parts and remove any obstructions
	The safe working load has been exceeded	Reduce the load

Malfunction	Possible cause	Possible solution
Motorised adjustment system not working properly	Drives not initialised or error saved	After resolving the error / professional repair: Clear errors and initialise drives (☞ P. 27).
Drives cut out after a long period of operation	The adjustment time or safe working load has been exceeded and the control unit has reacted to overheating	Allow the drive system to cool down sufficiently
Opposing functions are activated when the hand controller button is pressed	Motor plugs connected the wrong way round	Check that the cables are connected correctly or inform your operator, specialist retailer or our customer service
Side rails can no longer be properly adjusted	Mechanism blocked or bent	Check all moving parts and remove any obstructions or contact our customer service
Castors do not brake or cannot be rolled	Foreign objects have become trapped in the castors	Remove foreign objects
	The castor system is faulty	Contact our customer service

# PRODUCT SAFETY

This product bears the CE seal and therefore meets the requirements of the applicable German and European safety standards.

Laws and standards	Title
Regulation (EU) 2017/745	European Medical Device Regulation
MPDG	Medical devices implementation act
DIN EN ISO 13485	Quality management for medical devices – Requirements for regulatory purposes
DIN EN ISO 9001	Quality management systems
DIN EN ISO 14001	Environmental management systems
IEC 60601-2-52	Medical electrical equipment – Particularly requirements for safety
DIN EN 60601-1	Medical electrical equipment – General requirements for safety
DIN EN 60601-1-2	Medical electrical equipment – Electromagnetic (EM) disturbances
IEC 60601-1-6	Medical electrical equipment – Usability
DIN EN ISO 14971	Risk management for medical devices
IEC 62366	Medical devices – Application of usability engineering to medical devices
DIN EN ISO 20417	Medical devices – Requirements for the information to be supplied by the manufacturer
DIN EN ISO 15223-1	Symbols to be used with medical device labels
DIN EN 12182	Technical aids for disabled persons
DIN EN 12530/DIN EN 12531	Medical castors/hospital bed castors
DIN 33402-1	Ergonomics – Body dimensions of people
DIN 68861-1	Furniture surfaces – Resistance to chemical attack



# CLEANING AND DISINFECTION

## Disinfection

The care bed must be disinfected regularly, at least before every change of resident. All detergents in line with DIN EN 12720 are suitable for wipe-down disinfection of the bed. The care bed must not be disinfected in inline washing systems or using water spray. Only those disinfectants recommended by the RKI are permitted to be used for wipe and surface disinfection at the specified concentration. Complaints resulting from improper use e.g. hand disinfectant used for surface disinfectant, are excluded.

The detergents used for disinfection must only be used in line with the manufacturer's instructions.



**Caution! Under no circumstances use abrasives, cleaning pads or stainless-steel cleaners for cleaning. Before using any disinfectants, please consider the dosage and any potential hazards that may be caused by combining them with other substances. Remove the plug from the mains socket when disinfecting the care bed and protect the drive system from moisture.**

---

## Care of wooden parts

Malsch care beds only use wood surrounds that are finished in compliance with the DIN 68861-1A standard. The aim is to produce a comfortable design, maximum functionality and a high level of practical use. To ensure you are able to enjoy this product for as long as possible, we recommend cleaning with commercial furniture cleaning products and polishes.

Even after extremely careful selection and sorting of our wooden materials, the wood is subject to a natural ageing process. Over time, environmental influences such as air humidity, heat and UV radiation can cause changes in the colour of real wood surfaces, even when they are treated. Solid wood elements are a natural product with an individual grain and characteristics. Slight colour and shading differences within the same delivery are natural and technically unavoidable. For these reasons, relative shading and colour differences and marks due to natural growth patterns in real wood do not constitute a fault and Malsch GmbH can accept no liability or warranty claims for these.

## SAFE DECOMMISSIONING / STORAGE

Proceed as follows to safely decommission the bed or prepare the bed for storage:

- Disconnect the bed from the power by pulling out the mains plug.
- Activate the brake system.

### Storage

- The (optional) battery must be charged regularly to prevent deep discharge.
- Remove any accessories such as bed lamps, lifting poles etc.
- Cover the care beds so that the wood surround and the frame cannot be damaged.
- To ensure the necessary, regular maintenance intervals, attach the storage date on the bed in a visible location
- Lock the hand controller.
- Prior to prolonged storage, the batteries of the electric emergency lowering function should be removed to prevent damage caused by leaked battery acid.



Caution! The same conditions apply to the storage location of care beds as to the working environment (temperature, humidity, heat, etc.)

---



The manufacturer's transport aid must be used to transport the beds.

---

## ELECTROMAGNETIC COMPATIBILITY (EMC)

The bed is intended for operation in the electromagnetic environments listed below. The customer or user of the bed must ensure that it is used in a suitable environment.

### Guidelines and manufacturers' declarations – electromagnetic emissions

Emission measurement	Compliance	Electromagnetic environment directive
RF emissions, CISPR 11	Group 1	The bed uses HF energy exclusively for its internal functions. Therefore, it produces very low HF emissions, and it is unlikely that nearby electronic devices will be adversely affected.
RF emissions, CISPR 11	Class A	The bed is suitable for use in all inpatient / professional care.
HF emissions IEC 61000-3-2	Class A	
Voltage fluctuations and flicker IEC 61000-3-3	Compliant	

### Guidelines and manufacturers' declarations – electromagnetic resistance

Phenomena	EMC basic standard or test procedure	Inpatient / professional care industry environment	Compliance level	Electromagnetic environment directives
Static electricity discharge	IEC 61000-4-2	±8 kV contact	±8 kV contact	The flooring material must consist of wood or concrete. If synthetic materials are used, the relative humidity must be at least 30%.
		±2 kV; ±4 kV; ±8 kV; ±15 kV air discharge	±2 kV; ±4 kV; ±8 kV; ±15 kV air discharge	
High-frequency electromagnetic fields	IEC 61000-4-3	3 V/m	3 V/m	Portable and mobile radio devices must not be used closer to the care bed and its cables than the recommended distance calculated using the equation applicable to the frequency of the transmitter.
		80 MHz to 2.7 GHz	80 MHz to 2.7 GHz 80% AM at 1 kHz	

Magnetic fields with energetic rated frequencies	IEC 61000-4-8	30 A/m	30 A/m	Power-frequency magnetic fields must correspond to the typical value found in the business and hospital environments.
		50/60 Hz	50/60 Hz	
Electrical fast transient disturbances/ bursts	IEC 61000-4-4	±2 kV	±2 kV	The power supply quality must correspond to that of a typical business or hospital environment.
		100 kHz repetition frequency		
Surge voltage	IEC 61000-4-5	± 0.5; ±1 kV	± 0.5; ±1 kV	The power supply quality must correspond to that of a typical business or hospital environment.
Cable to cable				
Surge voltage	IEC 61000-4-5	± 0.5; ±1 kV; ± 2 kV	± 0.5; ±1 kV; ± 2	The power supply quality must correspond to that of a typical business or hospital environment.
Cable to ground				
Conducted disturbances induced by high-frequency fields	IEC 61000-4-6	3 V	3 V	
		6 V in ISM and amateur radio frequency bands	6 V in ISM and amateur radio frequency bands	
Voltage dips	IEC 61000-4-11	0% UT; ½ cycle at 0, 45, 90, 135, 180, 225, 270 and 315 degrees	0% UT; ½ cycle at 0, 45, 90, 135, 180, 225, 270 and 315 degrees	The power supply quality must correspond to that of a typical business or hospital environment.
		0% UT; 1 cycle and 70% UT; 25/30 cycles Single-phase: at 0 degrees	0% UT; 1 cycle and 70% UT; 25/30 cycles Single-phase: at 0 degrees	
Power failures	IEC 61000-4-11	0% UT; 250/300 cycles	0% UT; 250/300 cycles	If the user of the bed requires continued functionality even in the event of power supply disruptions, it is advisable to supply the bed with power from an uninterruptible power supply or from a battery.

## Interference resistance of enclosure ports to high-frequency wireless communication equipment

Test frequency [MHz]	Band [MHz]	Service	Modulation	Maximum power [W]	Distance [m]	Immunity test level [V/m]
385	380 to 390	TETRA 400	Pulse modulation 16 Hz	1.8	0.3	27
450	430 to 470	GMRS 460, FRS 460	Frequency modulation $\pm 5$ kHz Hub 1 kHz Sinus	2	0.3	28
710	704 to 787	LTE band 13, 17	Pulse modulation 217 Hz	0.2	0.3	9
145						
780						
810	800 to 960	GSM 800/900, TETRA 800, iDEN 820, CDMA 850, LTE band 5	Pulse modulation 18 Hz	2	0.3	28
870						
930						
1720	1700 to 1990	GSM 1800; CDMA 1900; GSM 1900; DECT; LTE band 1, 3,4,5; UMTS	Pulse modulation 217 Hz	2	0.3	28
1845						
1970						
2450	2400 to 2570	Bluetooth; WLAN 802.11 b/g/n, RFID 2450 LTE band 7	Pulse modulation 217 Hz	2	0.3	28
5240	5100 to 5800	WLAN 802.11 a/n	Pulse modulation 217 Hz	0.2	0.3	9
5500						
5785						

# WARRANTY AND SERVICE

By purchasing a care bed from Malsch GmbH, you have chosen a premium, high-quality product.

Malsch care beds are covered by a 24-month warranty calculated from the date of purchase.

In the event of material or manufacturing faults occurring within the warranty period, the bed will be replaced or repaired free of charge.

This excludes faults and errors caused by inappropriate handling or external influences.

Our normal terms of business and delivery apply.

If you have any questions, please contact us on the following numbers:

## Customer service

Phone: +49 (0) 6626 915-100  
Fax: +49 (0) 6626 915-127

info@bettenmalsch.de  
bettenmalsch.com

# DECLARATION OF CONFORMITY



DE

## EU-Konformitätserklärung

nach der Verordnung (EU) 2017/745 des europäischen Parlaments und des Rates vom 5. April 2017 über Medizinprodukte, Anhang IV.

Der Hersteller  
**Malsch GmbH**  
Rohbergstraße 9, 36208 Wildede  
Tel. +49 (0) 6626 915-100  
SRN DE-MF-60005173

erklärt in allererster Verantwortung, dass die nachfolgend benannten Produkte den grundlegenden Anforderungen und Bestimmungen der Verordnung (EU) 2017/745 für Medizinprodukte entsprechen und gemäß der Anhänge II, III und VIII (Regel 1.13) der Risikoklasse I zugeordnet werden:

Pflegebett: ALURA  
Pflegebett: IMPULSE  
Pflegebett: ATLEEN

Basic UDI-DI: 4065848MALSCH-PKL00002V

Die bezeichneten Produkte wurden unter Anwendung der folgenden Richtlinien und harmonisierten Normen produziert:

**Elektrische Sicherheit:**  
IEC 60601-1 A2:2020

**Mechanische Sicherheit:**  
IEC 60601-2-32:2009+A1:2015

**Elektromagnetische Verträglichkeit (EMV):**  
IEC 60601-1-2:2014

**Gebrauchstauglichkeit:**  
IEC 60601-1-6:2010+A1:2013  
IEC 62366-1:2015+C0R1:2016

**Risikomanagement:**  
DIN EN ISO 14971:2022-04

**Richtlinie zur Beschränkung gefährlicher Stoffe RoHS:**  
Richtlinie 2011/65/EU

Durch die Einhaltung der Bestimmungen der Verordnung (EU) 2017/745 werden die Anforderungen zur Anbringung einer CE-Kennzeichnung erfüllt. Aufgrund der Spezifikation als Medizinprodukt Klasse I werden Produkt und Verpackung spätestens ab Mai 2025 zusätzlich mit einer UDI-Kennzeichnung versehen. Eine Konformität der Produkte und Entwicklungsdokumentation sowie des QM-Systems wird durch die Zertifizierung nach DIN EN ISO 13485:2021 bestätigt.

Bei einer mit uns nicht abgestimmten Änderung des oben genannten Produktes verliert diese Erklärung ihre Gültigkeit.

Wildede, den 28.05.2024

Rajk Malsch  
Geschäftsführer CEO/Gerant

EN

## EC Declaration of Conformity

according to Regulation (EU) 2017/745 of the European Parliament and of the Council of 5 April 2017 concerning medical devices, Ann. IV

The manufacturer  
**Malsch GmbH**  
Rohbergstraße 9, 36208 Wildede, Germany  
Phone +49 (0) 6626 915-100  
SRN DE-MF-60005173

declares under its sole responsibility that the devices named below comply with the essential requirements and provisions of Regulation (EU) 2017/745 for medical devices and are assigned to risk class I in accordance with Annexes II, III and VIII (Rule 1.13):

Care bed ALURA  
Care bed IMPULSE  
Care bed ATLEEN

Basic UDI-DI: 4065848MALSCH-PKL00002V

The designated products have been produced in application of the following directives and harmonized standards:

**Electrical safety:**  
IEC 60601-1 A2:2020

**Mechanical safety:**  
IEC 60601-2-32:2009+A1:2015

**Electromagnetic Compatibility (EMC):**  
IEC 60601-1-2:2014

**Usability:**  
IEC 60601-1-6:2010+A1:2013  
IEC 62366-1:2015+C0R1:2016

**Risk Management:**  
DIN EN ISO 14971:2022-04

**Directive on the Restriction of Hazardous Substances RoHS:**  
Directive 2011/65/EU

By complying with the provisions of Regulation (EU) 2017/745, the requirements for affixing a CE marking are fulfilled. Due to the specification as a medical device class I, the product and packaging will additionally be provided with a UDI marking from May 2025 at the latest. Conformity of the product and development documentation as well as the QM system is confirmed by certification according to DIN EN ISO 13485:2021.

In the event of a modification of the above-mentioned product not agreed with us, this declaration loses its validity.

# CERTIFICATES

**CERTIFICATE**



for a management system as per

**EN ISO 13485:2016/AC:2018,  
EN ISO 13485:2016/A11:2021**

Evidence of conformity has been furnished.



**Malsch GmbH**  
Rohlsbergerstraße 9  
30209 Wilsack - Oberauß / Germany

**Scope - for the European Economic Area:**  
Development, manufacturing, distribution and servicing of clinic- and care bed systems, along with related consulting services, particularly in the areas of project planning and setting, within the medical field.

Certificate registration No.: 73 105 1297

Certificate valid from: 2023-11-17 to 2025-03-10





*Dr. Panide*

Dr. M. Panide  
Head of Certification body  
Malsch - Oberauß  
Certification Body of TÜV Hessen



Page 1 of 1  
This certificate, together with the associated registration number of the Certifying Body, constitutes evidence of conformity with the requirements of the applicable standard. It is not a substitute for the product or service itself. The certificate holder is responsible for the maintenance of the certificate. The certificate holder is responsible for the maintenance of the certificate. The certificate holder is responsible for the maintenance of the certificate.

**CERTIFICATE**



for a management system as per

**DIN EN ISO 9001:2015**

Evidence of conformity has been furnished.



**Malsch GmbH**  
Rohlsbergerstraße 9  
30209 Wilsack - Oberauß / Germany

**Scope:**  
Development, manufacture and distribution of medical beds and accessories

Certificate registration No.: 73 100 1297

Certificate valid from: 2024-11-20 to 2025-09-30

Start of certification cycle: 2023-10-01





*M. Panide*

Andrea Panide  
Head of Certification body  
Malsch - Oberauß  
Certification Body of TÜV Hessen



Page 1 of 1  
This certificate, together with the associated registration number of the Certifying Body, constitutes evidence of conformity with the requirements of the applicable standard. It is not a substitute for the product or service itself. The certificate holder is responsible for the maintenance of the certificate. The certificate holder is responsible for the maintenance of the certificate. The certificate holder is responsible for the maintenance of the certificate.

**CERTIFICATE**



for a management system as per

**DIN EN ISO 14001:2015**

Evidence of conformity has been furnished.



**Malsch GmbH**  
Rohlsbergerstraße 9  
30209 Wilsack - Oberauß / Germany

**Scope:**  
Development, manufacture and distribution of medical beds and accessories

Certificate registration No.: 73 104 1297

Certificate valid from: 2024-11-20 to 2025-09-30

Start of certification cycle: 2023-10-01





*M. Panide*

Andrea Panide  
Head of Certification body  
Malsch - Oberauß  
Certification Body of TÜV Hessen



Page 1 of 1  
This certificate, together with the associated registration number of the Certifying Body, constitutes evidence of conformity with the requirements of the applicable standard. It is not a substitute for the product or service itself. The certificate holder is responsible for the maintenance of the certificate. The certificate holder is responsible for the maintenance of the certificate. The certificate holder is responsible for the maintenance of the certificate.

Item No. 91300 130103.4  
EN, Updated 01/2025, Rev. 3.4  
Colours may vary  
Subject to technical changes

